

Aug. 1. 2022 Copyright 2022 HIROSE ELECTRIC CO., LTD. All Rights Reserved.
 In case of consideration for using Automotive equipment / device which demand high reliability, kindly contact our sales window correspondents.

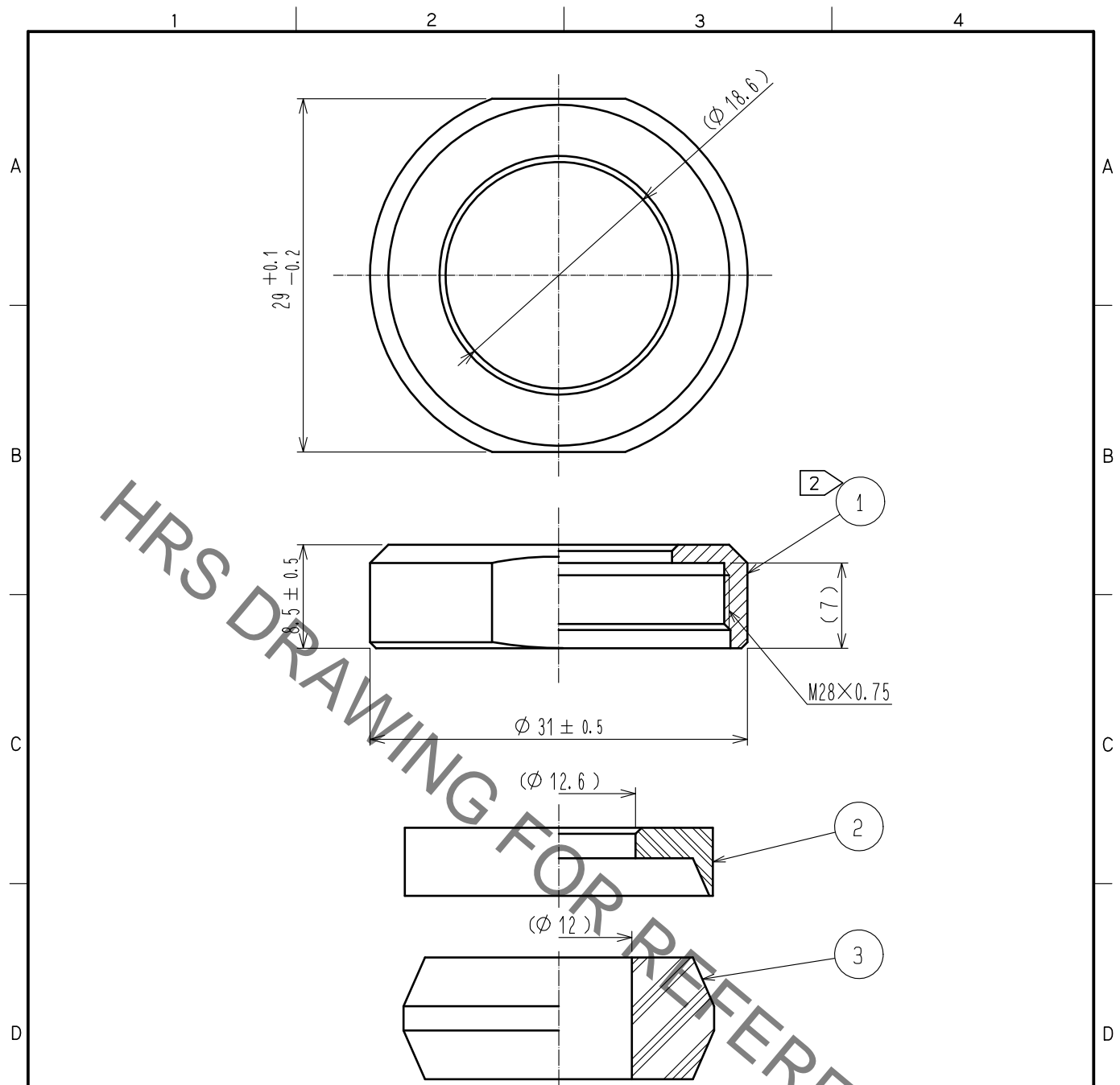

- Notes
1. This product is delivered disassembled.
 2. The recommended clamp torque of ref. No. ① : 5 to 5.5 N · m .
 LOCTITE 263, HENKEL JAPAN or equivalent is recommended to prevent ref. No. ① from loosening.
 3. The cable pull and twisting strength, waterproof tightness and other characteristics may differ, depending on the cable structure. Please confirm before the use.

2	PPS	(Black) UL94V-0						
1	Brass	Black chrome plating	3	Acrylonitrile butadiene rubber	(Gray)			
NO.	MATERIAL	FINISH .	REMARKS	NO.	MATERIAL	FINISH .	REMARKS	
UNITS mm		SCALE 2 : 1	COUNT 	DESCRIPTION OF REVISIONS		DESIGNED	CHECKED	DATE
HIROSE ELECTRIC CO., LTD.		APPROVED	·HY. KOBAYASHI	18. 02. 26	DRAWING NO.	EDC-110631-31-00		
		CHECKED	·HY. KOBAYASHI	18. 02. 26	PART NO.	JR25WCCA-12(31)		
		DESIGNED	·TH. KAMEYA	18. 02. 24	CODE NO.	CL114-2089-6-31		
		DRAWN	·MK. INOUE	18. 02. 14				