

Measurement & Automation Board

The M&A Board is an off-the-shelf test jig that makes end of line testing and benchtop automation easy. Seamlessly integrate with the MagicDAQ USB DAQ or pair with a DAQ module of your choice to access a comprehensive suite of testing capabilities.

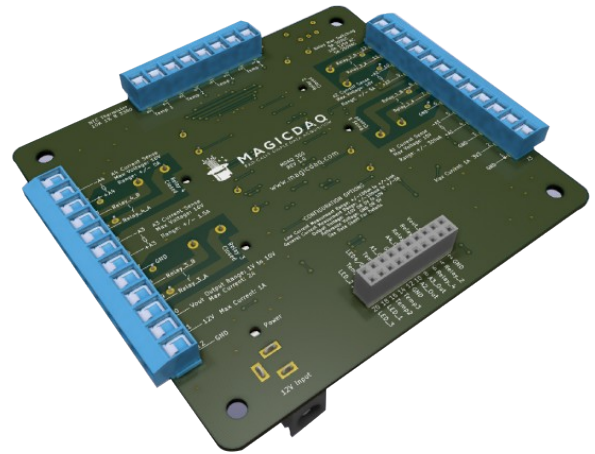

- 3 General current measurement circuits (5A max)
- 1 Low current measurement circuit (uAs)
- 4 Temperature measurement probes (-55C - 125C)
- 4 Switching relays (7A max)
- 1 Variable voltage power output (1V - 10V, 2A max)
- 2 Fixed power outputs (3.3V & 12V)
- Use stand alone or mount to a custom PCB

Technical Specifications

Current Measurement – 3 Channels: A2, A3, A4				
Maximum Applied Voltage		-10V to +16V (relative to GND)		
Default Current Measurement Ranges				
		A2	+/- 5A	
		A3	+/- 1.5A	
		A4	+/- 5A	
Sense Resistors (Vref =0V)				
Measurement Range	MagicDAQ Resolution	Resistance	Part #	Details
+/- 500 mA	0.13 mA	0.1 Ohm	ERJ-8BWFR100V	Size 1206; Tolerance +/- 1%; Power 1W
+/- 1.5A	0.38 mA	0.033 Ohm	KRL1632E-M-R033-F-T5	Size 1206; Tolerance +/- 1%; Power 3/4W
+/- 5A	1.26 mA	0.01 Ohm	CRF1206-FZ-R010ELF	Size 1206; Tolerance +/- 1%; Power 1W
Output Voltage		Vout = (Current * Sense Resistor Resistance * 200) + Vref Current flow from +A to -A is positive, reverse is negative. Voltage output pins: A2_Out – A4_Out on DAQ Header.		
Output Voltage Range		Default: -10V to 10V (Vref = 0V) Alternative: 0V to 10V (Vref = 5V)		
Current Equation		Current = (Vout – Vref)/(Sense Resistor Resistance *200)		
Switching Relays – 4 Channels: Relay_1, Relay_2, Relay_3, Relay_4				
Maximum Switching Capacity		5A 30V DC; 7A 160V AC		
Maximum Contact Resistance		0.1 Ohm		
Relay Control		Input pin > 2.1V : Relay Closed. Maximum input voltage : 20V. Input pin = 0V : Relay Open. Input pins: Relay_1 – Relay_4 on DAQ Header.		
ON / OFF Indication: LED		LED ON = Relay Closed. Located near relevant screw terminals		
ON / OFF Indication: Digital Output		Output pin sink to GND : Relay Closed. Output pin = 12V : Relay Open. Output pins: LED_1 – LED_4 on DAQ Header.		
PCB Routing – Creepage & Clearance		Creepage & Clearance: 1.8mm. IEC 62368-1 Mains Basic Insulation, Pollution Degree 2, Material Group III, <2000m		

Low Current Measurement – 1 Channel: A1				
Maximum Applied Voltage		-10V to +10V (relative to GND)		
Default Current Measurement Range		+/- 300uA		
Sense Resistors (Vref = 0V)				
Measurement Range	MagicDAQ Resolution	Resistance	Part #	Details
+/- 100 uA	0.025 uA	1K Ohm	RNCP1206FTD1K00	Size 1206; Tolerance +/- 1%;Power 1/2W
+/- 300 uA	0.076 uA	332 Ohm	RNCP1206FTD332R	Size 1206; Tolerance +/- 1%;Power 1/2W
+/- 600 uA	0.152 uA	169 Ohm	ERJ-8ENF1690V	Size 1206; Tolerance +/- 1%;Power 1/4W
+/- 1 mA	0.253 uA	100 Ohm	RNCP1206FTD100R	Size 1206; Tolerance +/- 1%;Power 1/2W
Output Voltage		Vout = (Current * Sense Resistor Resistance * 97.863) + Vref Current flow from +A1 to -A1 is positive, reverse is negative. Voltage output pin: A1_Out on DAQ Header.		
Output Voltage Range		Default: -10V to 10V (Vref = 0V) Alternative: 0V to 10V (Vref = 5V)		
Current Equation		Current = (Vout – Vref)/(Sense Resistor Resistance *97.863)		
Temperature Measurement – 4 Channels: Temp 1, Temp 2, Temp 3, Temp 4				
Thermistor Probe Temperature Measurement Range		-55C to 125C		
Thermistor Lead Wire Temperature Range		-55C to 105C		
Thermistor Temperature Measurement Accuracy		+/-0.25C		
Thermistor Type		10k NTC Thermistor		
NTC B Value		3380 +/- 1%		
MagicDAQ Resolution		.045 C		
Output Voltage		Vout = (Rtherm / (10000 + Rtherm)) * 10 Voltage output pins: Temp1 - Temp4 on DAQ Header.		
Output Voltage Range		0V to 10V		
Temperature Equation				
$R_{therm} = -1 * ((10000 * V_{out}) / (V_{out} - 10))$ $Temp (C) = (0.05 * (11118812057923532 - 1084982512647294 * \ln(R_{therm}))) / (422282259763 + 198605621938 * \ln(R_{therm}))$ ln() in above equation is Natural Logarithm Derived from equation: B Value = ln(Rtherm / 10000) / ((1/ (Temp in C + 273.15)) – (1/ (25 + 273.15)))				
Variable Voltage Power Output – 1 Channel: Vout				
Output Voltage Range		1V to 10V		
Maximum Output Current		2A		
Voltage Output Control		Vout = (-1.8 * Vout_set) + 10 Vout_set on DAQ Header (0V to 5V input).		
Fixed Voltage Power Output – 2 Channels: 3V3, 12V				
3V3 Maximum Output Current		0.5A		
12V Maximum Output Current		1A		

Accessory Set

Board Mount	See M&A board mechanical drawing
4 NTC Thermistor Temperature Probes	700 mm length
M&A Board Power Supply	12V Output 100 VAC – 230 VAC Input, 50/60Hz Socket adapters for all markets: USA, EU, NZ/AUS, CN
USB DAQ / M&A Board Interface Cable	20 pin ribbon cable connected with male header pins Cable: 228mm Length (1/2 of Part # H3CCH-2018G) Male Pins: PRPC010DABN-RC

Configuration Options

Stand Alone	Mount to Custom PCB
-------------	---------------------

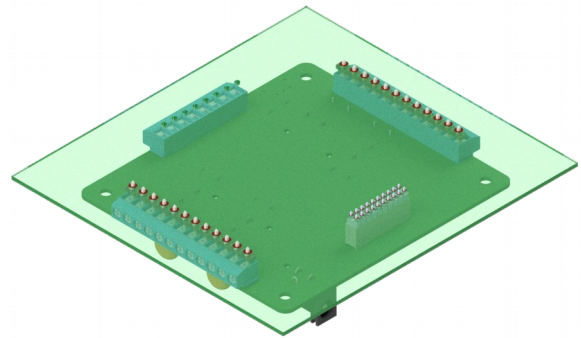
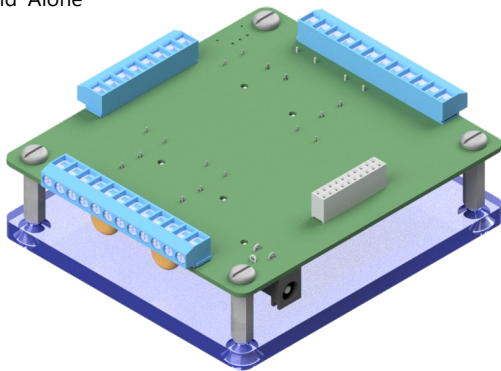

Use board mount	Typical custom PCB: bed of nails test fixture See M&A Board PCB Mount Pattern (last page of data sheet) Separately purchase PCB mount connectors
-----------------	--

Notes

Select Current Measurement Range

Visit magicdaq.com to customize your M&A board order.

Alternatively, you can easily replace the 1206 size sense resistors on the back of the M&A Board. They are clearly marked as shown.

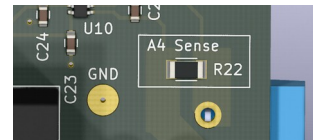

Current Measurement Output Voltage Range (Vref)

The default output voltage range is -10V to 10V (Vref = 0V).

Alternatively, you can configure the M&A Board for 0V to 10V output (Vref = 5V). You will need to:

- 1) Populate the 5V reference on the back of the board. You will need to separately purchase:

Part Type	Part Number
5V Reference	LM4040AIZ-5.0/NOPB
1K Ohm Axial Resistor	CF14JT1K00

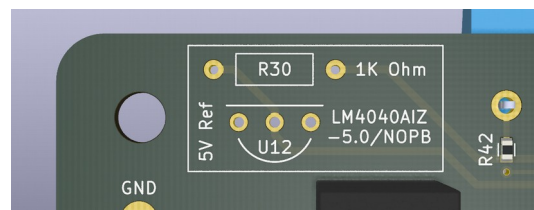

- 2) For each current measurement channel you wish to set to 0V to 10V range, you must populate the 5V reference jumper with a 0603 size 0 Ohm resistor and depopulate the GND jumper. In the example shown, R28 would be populated and R26 would be unpopulated.

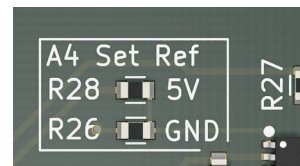

- 3) If all current measurement channels are set to 0V to 10V range, it is highly recommended to set the 'Low Voltage' to GND. This voltage powers the current measurement circuitry. When it is set to GND, it is impossible for the current measurement output to go below GND – which will protect the DAQ connected to the M&A Board.

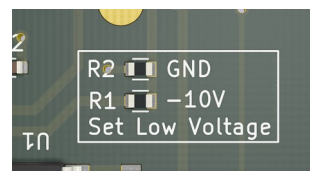

Place a 0603 0 Ohm resistor in the GND location and depopulate the -10V location. In the example shown, R2 would be populated and R1 would be unpopulated.

Notes

Measurement Resolution

The 'MagicDAQ Resolution' shown is typical when the MagicDAQ USB DAQ (14 Bit ADC) is paired with the M&A Board. You can calculate the theoretical maximum resolution for your application using the following formula.

Theoretical Maximum Resolution = Total Measurement Range / $2^{(ADC\ Bits)}$

For example: +/- 1.5A current measurement range with 14 Bit ADC: $3.0\ A / (2^{14}) = 0.183\ mA$

You will notice that the theoretical maximum resolution is substantially smaller than the figures listed under 'MagicDAQ Resolution'. In practice some resolution should be sacrificed by rounding ADC output to produce consistent data without excessive jitter.

M&A Board DAQ Header Pin 15: LED4 / GND

By default, DAQ Header pin 15 is GND.

Alternatively, this pin can be configured to be LED4 (Relay 4 Digital Output). LED4 outputs 12V when relay 4 is closed, 0V when relay 4 is open.

When configured as LED4, this pin should not be connected to the USB DAQ.

To configure as LED4, place a 0603 0 Ohm resistor in the Relay_4_LED location. Depopulate the GND location. In the example shown, R44 would be populated and R43 would be unpopulated.

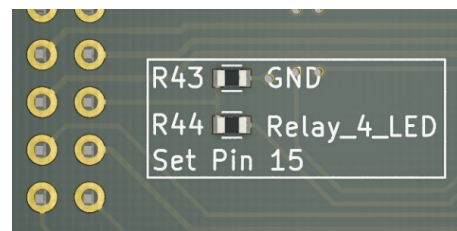

Variable Voltage Power Output – Vout Accuracy

The Vout voltage is stable under constant current draw, typically fluctuating within +/- 0.02V.

The Vout equation typically predicts the actual output voltage within +/- 0.3V. The Vout_set to Vout relationship is linear, and a transfer function specific to the individual M&A board may be derived simply by recording several Vout and Vout_set measurements and finding the best fit line. Typically, a transfer function specific to the M&A board can predict output voltage within +/- 0.1V.

If an even greater degree of output voltage accuracy is needed, consider connecting a voltage measurement input from the DAQ to Vout. A closed loop control function can then be implemented in software to set Vout_set.

Electrical Safety – Relay Switching 120 VAC

If the relays are being used to switch 120 VAC, the entire M&A Board should be placed in an enclosure in order to achieve double insulation per IEC 62368. Please keep safety in mind; only trained professionals should interact with mains power.

M&A Board Pinout

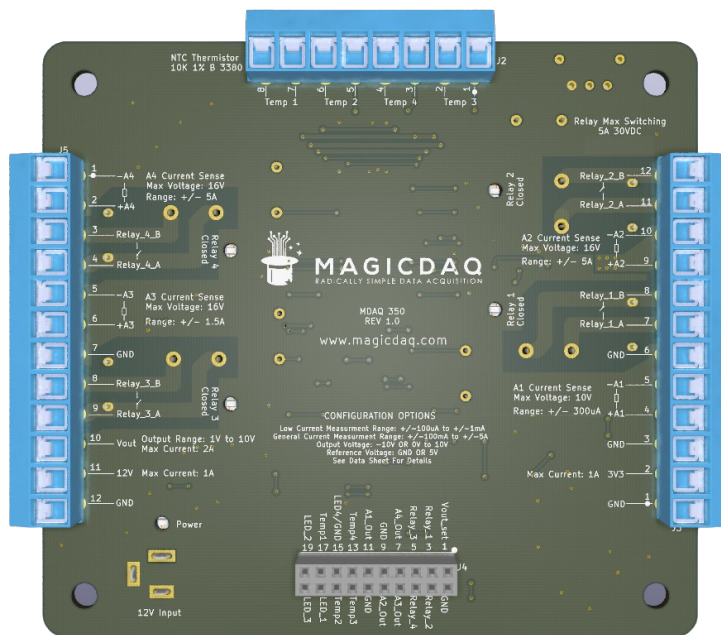
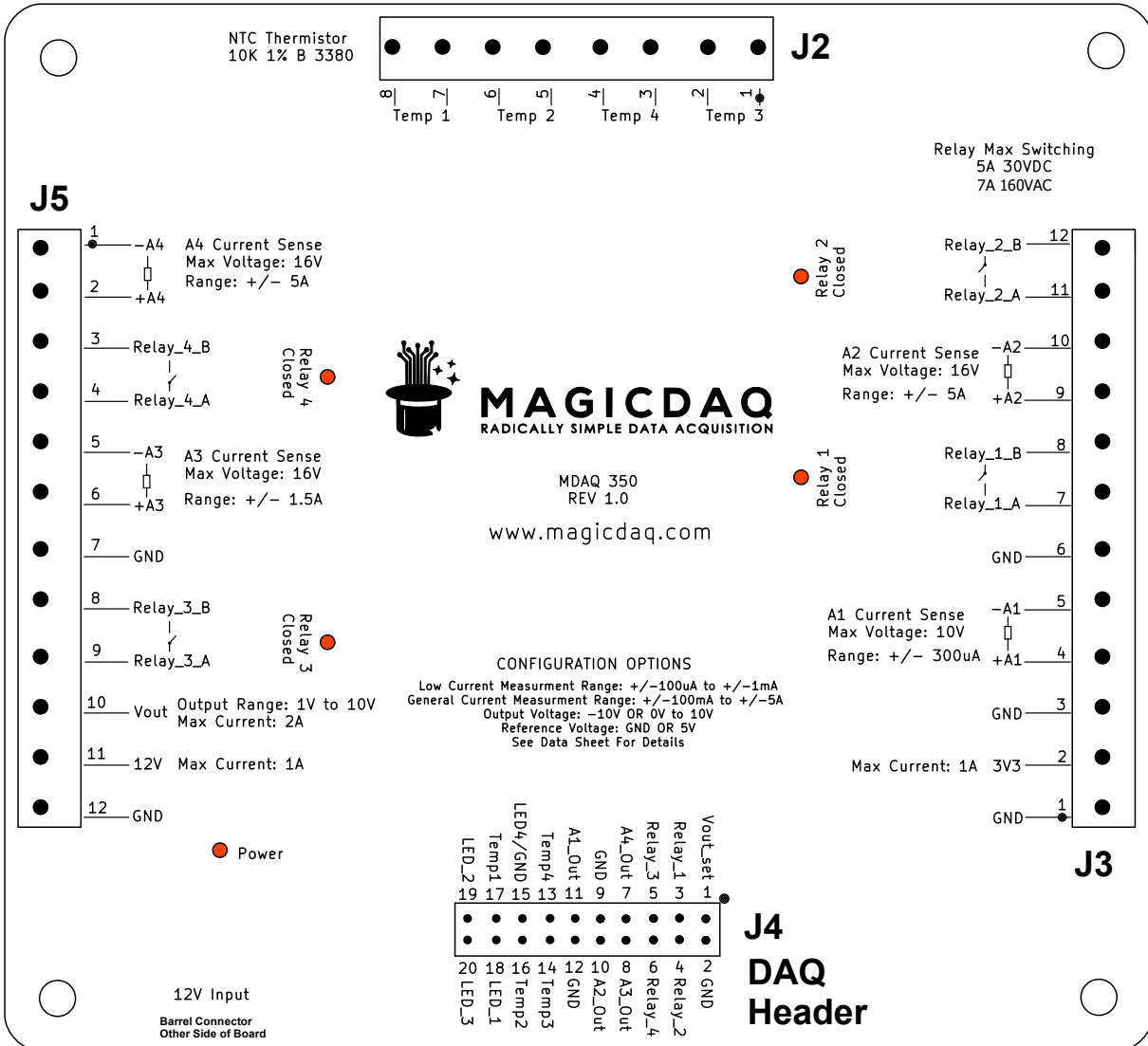

M&A Board DAQ Header to MagicDAQ USB DAQ Pin Mapping

M&A Board DAQ Header J4 Pin #	M&A Board DAQ Header Pin Description	MagicDAQ USB DAQ Pin #	MagicDAQ USB DAQ Pin Description	Note
1	Vout_set	23	A00	Variable voltage power output control. $V_{out} = (1.8 * V_{out_set}) + 1$
2	GND	22	DGND	GND
3	Relay_1	21	P0.7	Relay 1 control. Input high = relay closed. Input low = relay open.
4	Relay_2	20	P0.6	Relay 2 control. Input high = relay closed. Input low = relay open.
5	Relay_3	19	P0.5	Relay 3 control. Input high = relay closed. Input low = relay open.
6	Relay_4	18	P0.4	Relay 4 control. Input high = relay closed. Input low = relay open.
7	A4_Out	11	AI7	Current measurement A4 output voltage.
8	A3_Out	10	AI6	Current measurement A3 output voltage.
9	GND	9	AGND	GND
10	A2_Out	8	AI5	Current measurement A2 output voltage.
11	A1_Out	7	AI4	Low current measurement A1 output voltage.
12	GND	6	AGND	GND
13	Temp4	5	AI3	Temperature 4 output voltage.
14	Temp3	4	AI2	Temperature 3 output voltage.
15	LED4 / GND	3	AGND	Default function: GND Alternative: Relay 4 Digital Output. 12V = Relay Closed. 0V = Open. Do not connect to MagicDAQ.
16	Temp2	2	AI1	Temperature 2 output voltage.
17	Temp1	1	AI0	Temperature 1 output voltage.
18	LED_1			Relay 1 Digital Output. 12V = Relay Closed. 0V = Open. Do not connect to MagicDAQ USB DAQ.
19	LED_2			Relay 2 Digital Output. 12V = Relay Closed. 0V = Open. Do not connect to MagicDAQ USB DAQ.
20	LED_3			Relay 3 Digital Output. 12V = Relay Closed. 0V = Open. Do not connect to MagicDAQ USB DAQ.

J4 DAQ Header

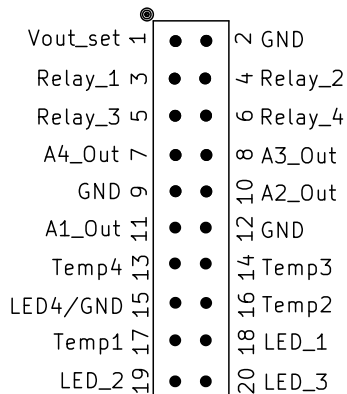

Interface Cable

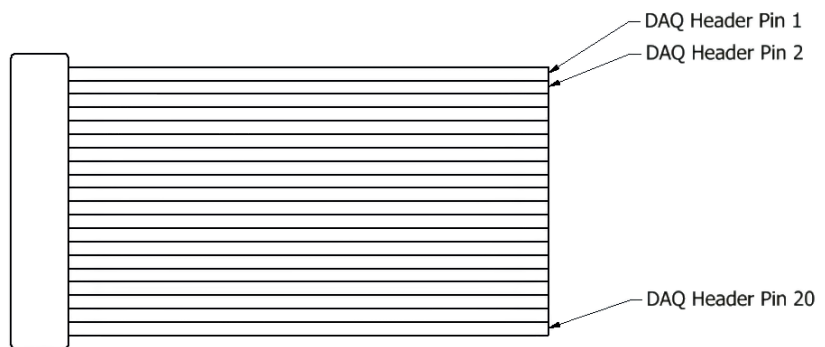

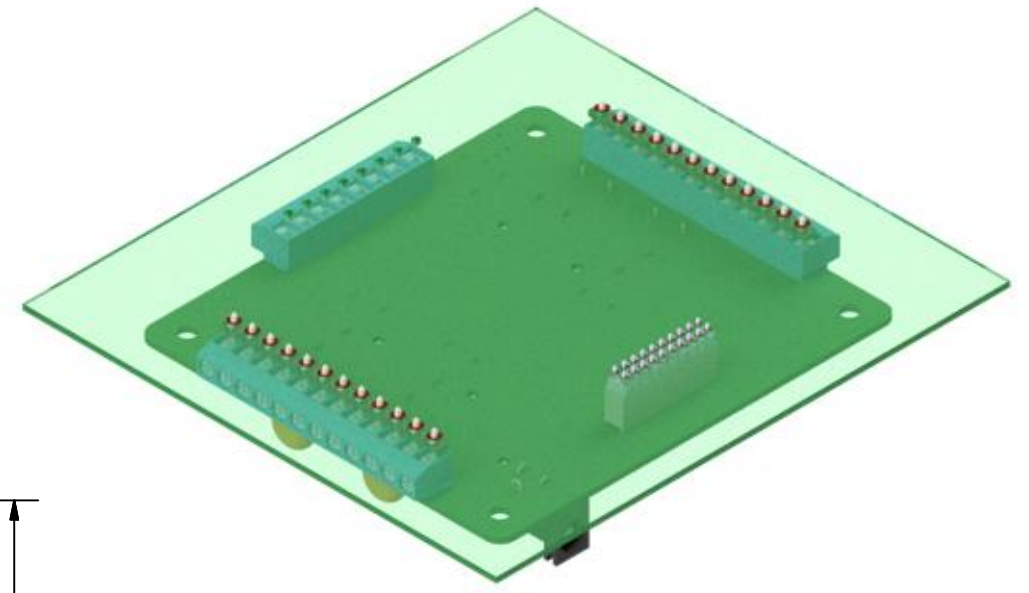
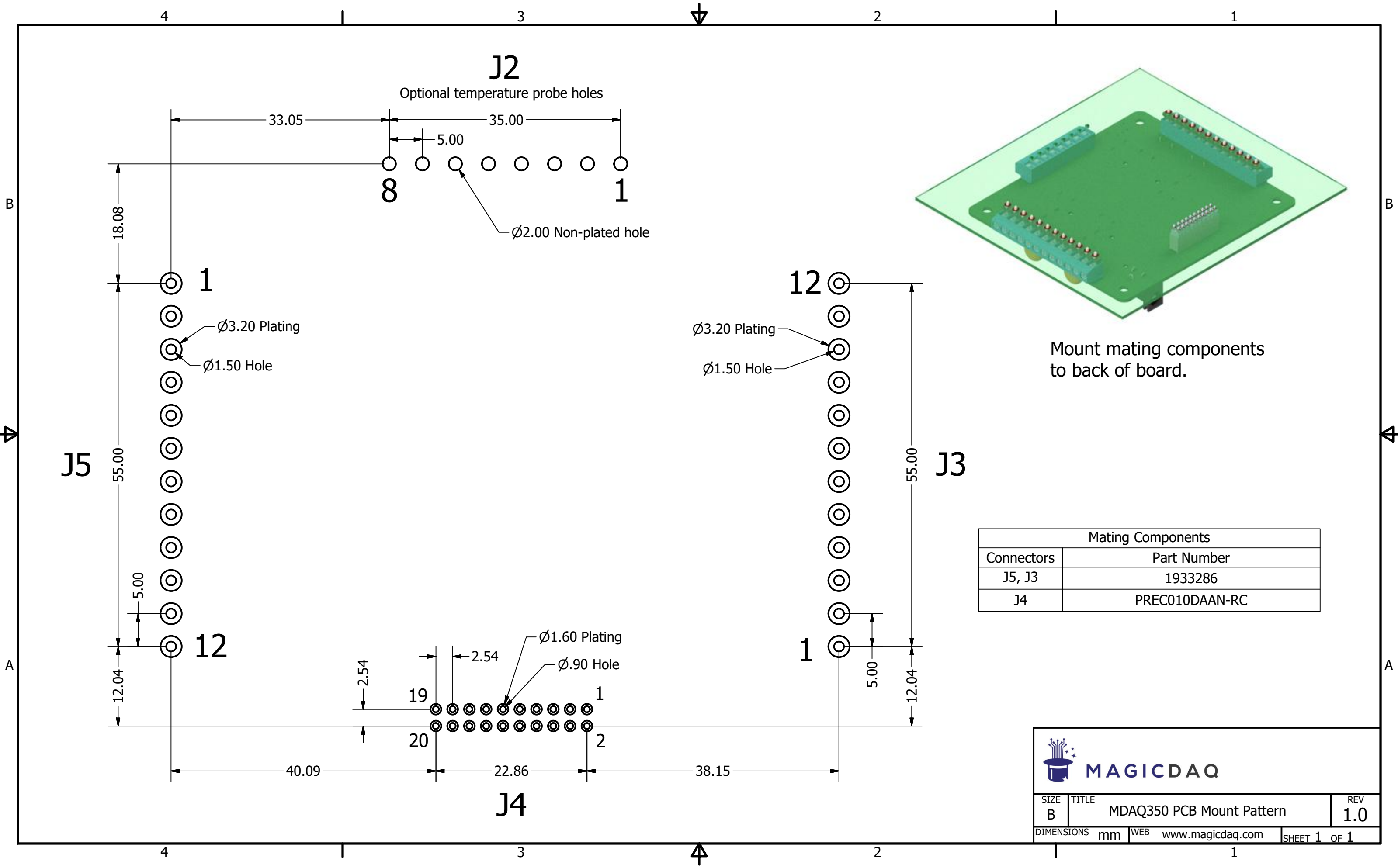

Mount mating components to back of board.

Mating Components	
Connectors	Part Number
J5, J3	1933286
J4	PREC010DAAN-RC

SIZE B

TITLE MDAQ350 PCB Mount Pattern

DIMENSIONS mm

WEB www.magicdaq.com

REV 1.0

SHEET 1 OF 1