

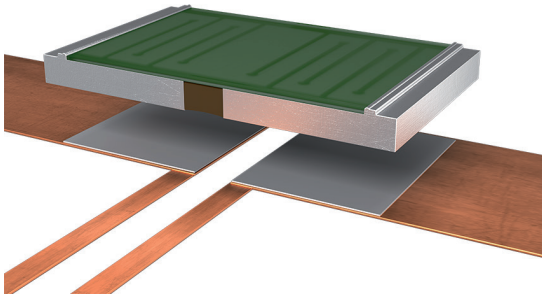

## ISA-PLAN® // PRECISION RESISTORS



### SMS // Size 2512



#### Features

- 5 W power rating at 70 °C
- Constant current up to 25 A (5 mOhm)
- Excellent long-term stability
- High pulse power rating
- Mounting: Reflow-, and IR-soldering
- AEC-Q200 qualified
- RoHS 2011/65/EU compliant



#### Applications

- Current sensor for power hybrid applications
- Control systems for the automotive market
- Power modules
- Frequency converters
- Switch mode power supplies

#### Technical data

Resistance values	<b>Ohm</b>	0.005 to 1 *
Tolerance	<b>%</b>	0.5 / 1 / 2 / 5 *
Temperature coefficient (20-60 °C)	<b>ppm/K</b>	<50
Applicable temperature range	<b>°C</b>	-65 to +170
Power rating <b>P<sub>110°C</sub></b>	<b>W</b>	3
Power rating <b>P<sub>70°C</sub></b>	<b>W</b>	5
Internal heat resistance (R <sub>thi</sub> )	<b>K/W</b>	20
Dielectric withstanding voltage	<b>V AC/DC</b>	200
Inductance	<b>nH</b>	<3
Stability (at rated power) deviation after 2000h T <sub>K</sub> = Terminal temperature		<0.5% (T <sub>K</sub> = 80 °C) <1.0% (T <sub>K</sub> = 110 °C)

\* For detailed information see table on page 3

#### Ordering code

SMS - R005 - 1.0

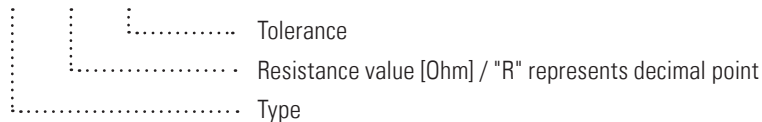



SMS // Size 2512

**Recommended solder profile**

Reflow- and IR-soldering				
Temperature	°C	260	255	217
Time	sec	peak	40	90

Slight deformations during soldering do not affect technical properties of the component.

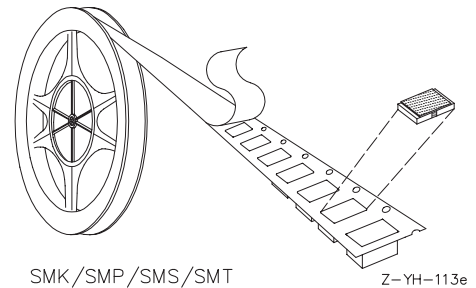

**Tape and reel information**

Specification		DIN EN 60286-3		
Tape width	mm	12		
Reel size	inch	13		
Parts per reel	pcs	5000		
Packaging weight	g	453		

**Power derating curve at 70 °C**

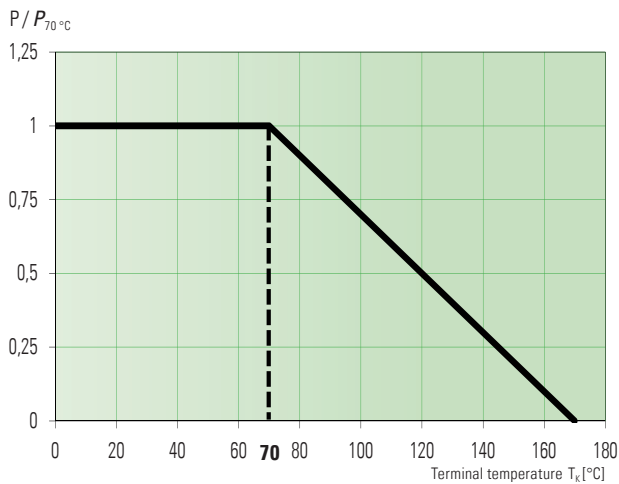

**Power derating curve**

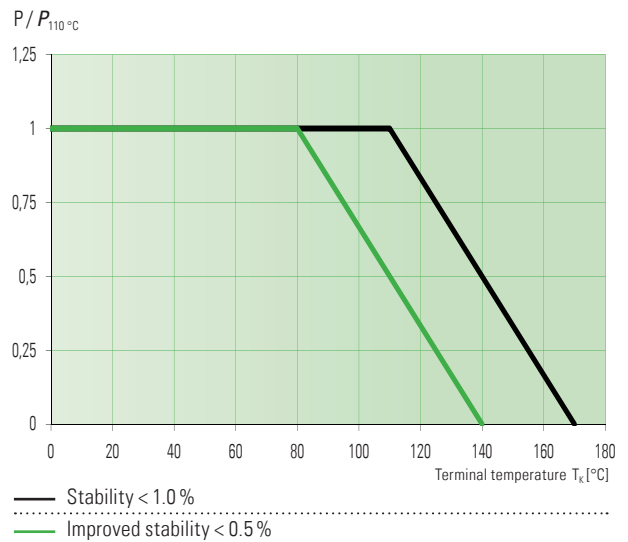

**Temperature dependence of the electrical resistance of SMS resistors**

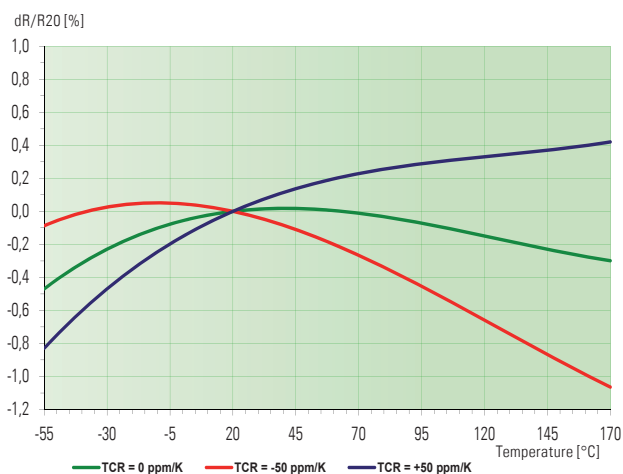



SMS // Size 2512

Available standard resistance values and tolerances\*

Resistance values	Tolerance			
	0.5	1.0	2.0	5.0
R005		✓		✓
R0056				✓
R0068		✓		
R0075		✓		
R008		✓		
R009		✓		
R010		✓		
R012		✓		
R0143		✓		
R015		✓		
R0173		✓		
R018		✓		
R020	✓	✓		
R022		✓		✓
R025		✓		
R030		✓		✓
R033		✓		
R039		✓		
R040	✓	✓		
R047		✓		
R050	✓	✓		
R068	✓	✓		
R075		✓		
R082		✓		
R100	✓	✓		
R120		✓		✓
R150	✓	✓		✓
R180		✓		
R200	✓	✓	✓	
R220	✓	✓		
R250		✓		✓
R270		✓		
R330	✓	✓		
R390		✓		
R470		✓		
R500		✓		
R680		✓		
R820		✓		
1R00	✓	✓	✓	

\* Further values and tolerances on request

✓ = available



SMS // Size 2512

**Mechanical dimensions and pcb-layout proposal (Reflow-soldering) [mm] // Z-YE-660a**

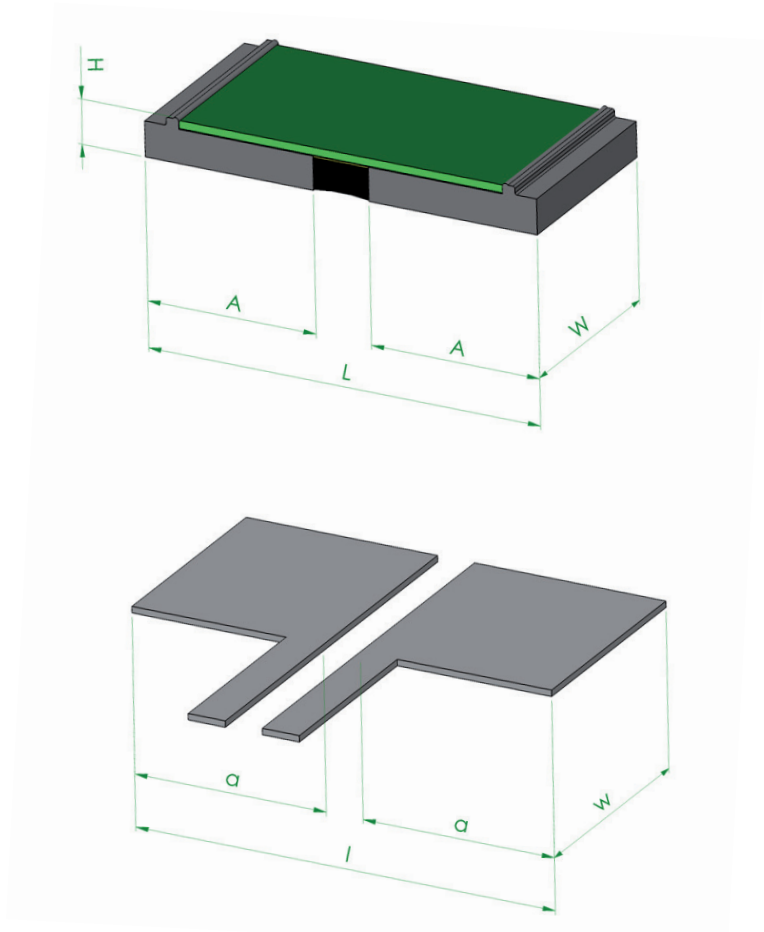

type:	L	W	H	A
SMS	6.35 ±0.2	3.05 ±0.1	0.8 ±0.2	2.725 ±0.4

solder pad type:	l	w	a
SMS	6.8	3.5	3.1



**Maximum pulse energy respectively pulse power for permanent operation**

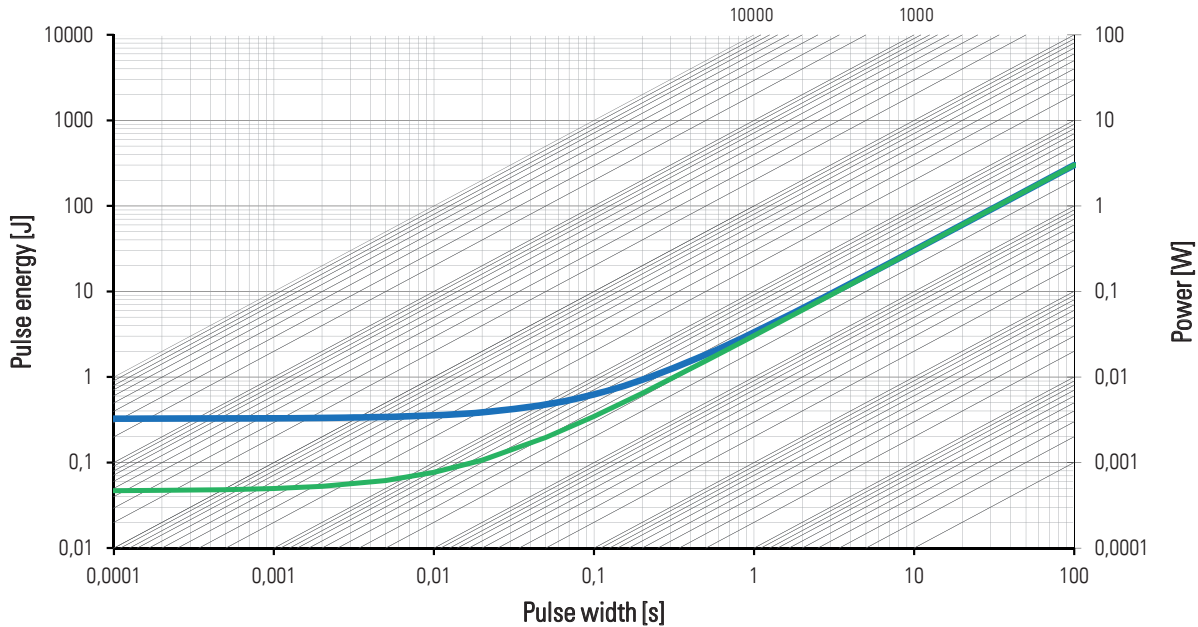

— This curve is only valid for the resistance value R005  
 — This curve is only valid for the resistance value 1R00

**Specification**

Parameters	Test conditions	Specified values
Temperature Cycling	2000 cycles (-55 °C to +150 °C)	±0.5%
Low Temperature Storage and Operation	-65 °C for 250 h	±0.1%
Resistance to Soldering Heat	260 °C for 10 sec / 8h steam aging	±0.3%
Moisture Resistance	MIL-STD-202 method 106	±0.1%
Mechanical Shock	100 g, 6 ms half sine	±0.1%
Vibration, High Frequency	10 g, 10-2000 Hz, 24 h each axis	±0.1%
Operational Life	2000 h, T <sub>k</sub> max at rated power	±1.0%
High Temperature Exposure	2000 h / 170 °C	±1.0%
Bias Humidity	+85 °C, 85 r.F., 1000 h	±0.5%

**Disclaimer** // All products, product specifications and data are subject to change without notice.

The product specifications do not expand or otherwise modify Isabellenhütte's terms and conditions of sale, including but not limited to, the warranty expressed therein. Isabellenhütte makes no warranty, representation or guarantee other than as set forth in its terms and conditions of sale.

Information provided in datasheets and/or specifications may vary from actual results in different applications. Any statements made by Isabellenhütte regarding the suitability of products for certain types of applications are based on its knowledge of typical requirements that are often placed on its products. It is the customer's responsibility to validate that a particular product with the properties described in the product specification is suitable for use in the application intended.

No license, express or implied, or otherwise, to any intellectual property rights is granted by this document.

Any and all liability arising out of the application or use of any product shall be as set forth in Isabellenhütte's terms and conditions of sale.

