

SECTION "C-C"

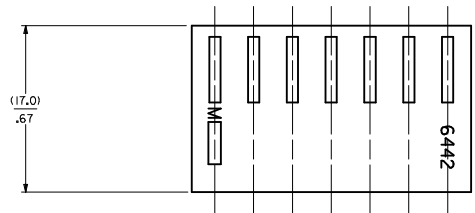

NO. OF CKT'S.	DIM. A	DIM. B
1	-----	(4.78±.18)
2	(3.96±.13)	.188±.007
3	.156±.005	(8.74±.18)
4	(7.92±.13)	.344±.007
5	.312±.005	(12.70±.18)
6	(11.89±.13)	.500±.007
7	.468±.005	(16.66±.18)
8	(15.85±.13)	.656±.007
9	.624±.005	(20.62±.18)
10	(19.81±.13)	.812±.007
11	.780±.005	(24.59±.18)
12	(23.77±.13)	.968±.007
13	.936±.005	(28.55±.18)
14	(27.74±.25)	1.124±.007
15	1.092±.010	(32.51±.30)
16	(31.70±.25)	1.280±.012
17	1.248±.010	(36.47±.30)
18	(35.66±.25)	1.436±.012
19	1.404±.010	(40.44±.30)
20	(39.62±.25)	1.592±.012
21	.4359±.25	(44.40±.30)
22	(43.59±.25)	1.748±.012
23	1.716±.010	(48.36±.30)
24	(47.55±.30)	1.904±.012
	1.872±.012	(52.32±.36)
	(51.51±.36)	2.060±.014
	2.028±.014	(56.29±.41)
	(55.47±.36)	2.216±.016
	2.184±.014	(60.25±.41)
	(59.44±.36)	2.372±.016
	2.340±.014	(64.21±.41)
	(63.40±.36)	2.528±.016
	2.496±.014	(68.17±.41)
	(67.36±.36)	2.684±.016
	2.652±.014	(72.14±.41)
	(71.32±.36)	2.840±.016
	2.808±.014	(76.10±.41)
	(75.29±.46)	2.996±.016
	2.964±.018	(80.06±.51)
	(79.25±.46)	3.152±.020
	3.120±.018	(84.02±.51)
	(83.21±.46)	3.308±.020
	3.276±.018	(87.99±.51)
	(87.17±.46)	3.464±.020
	3.432±.018	(91.95±.51)
	(91.14±.46)	3.620±.020
	3.588±.018	(95.91±.51)
		3.776±.020

- NOTES:
1. MATERIAL A: NYLON 6/6 UL94V-2, COLOR: NATURAL
  2. FINISH: N/A
  3. THIS PART COMPLIES WITH PRODUCT SPECIFICATION PS-40-02.
  4. PACKAGING SPECIFICATION: PK-6442-001
  5. HOUSING SHOWN ABOVE IS STANDARD HOUSING WITH NO OPTIONS.
  6. THIS HOUSING FOR USE WITH TERMINAL NO., 45570-x, (18-20 GA.) WITH (3.12)/.123 MAX. INSULATION DIA. 6838-x, (18-24 GA.) WITH (2.79)/.110 MAX. INSULATION DIA. 7258-x, (22-26 GA.) WITH (1.65)/.065 MAX. INSULATION DIA.
  7. LAST CIRCUIT I.D. NOT PRESENT ON 2-3 CIRCUIT HOUSINGS AND MAY OR MAY NOT BE PRESENT ON 4 CIRCUIT HOUSINGS AND LARGER.
  8. THIS PART CONFORMS TO CLASS B REQUIREMENTS OF COSMETIC SPECIFICATION PS-45499-002.
  9. SEE SHEET 2 FOR OPTIONS.
  10. TEXT ON PART IS FOR REFERENCE ONLY. TEXT AND TEXT LOCATION MAY VARY DEPENDING ON PART NUMBER AND/OR TOOL.

HOUSING OPTIONS

CODE	HOOKS	SIDE HOOKS	RAMP
BLANK	NONE	NONE	NONE
A	NONE	YES	NONE
R	NONE	NONE	FRICITION
B	NONE	NONE	TYPE B
C	NONE	NONE	TYPE C

6442-\*N-\*-\*-\*

VOLTAGE RATING OPTION  
BLANK=NONE  
V= '250 VAC' ON HOUSING

MAT'L OPTION  
BLANK= MATERIAL A (SEE NOTE 1)

MOLDED VOID CODE  
Z=NO VOIDS  
A=CKT. 1 VOID,  
B=CKT. 2 VOID, ETC.  
5=1ST MULTIPLE VOID,  
52=2ND MULTIPLE VOID, ETC.

NO. OF CKT'S.

QUALITY SYMBOLS	GENERAL TOLERANCES (UNLESS SPECIFIED)	DIMENSION STYLE	SCALE	DESIGN UNITS	THIRD ANGLE PROJECTION
▽=0	mm INCH	MM/IN	---	INCH	☉
▽=0	4 PLACES ±.010	DRAWN BY POLGAR	DATE 1986/12/03	TITLE KK (3.96)/.156 TRIFURCON CRIMP TERMINAL HOUSING 6442 SERIES	
▽=0	3 PLACES ±.014	CHECKED BY PATEL	DATE 1986/12/03	molex	
▽=0	2 PLACES ±.025	APPROVED BY LENZ	DATE 1986/12/03	MATERIAL NO. SEE CHART	DOCUMENT NO. SD-6442
▽=0	1 PLACE ±.036	ANGULAR ±1/2°			
▽=0	0 PLACE ±	DRAFT WHERE APPLICABLE MUST REMAIN WITHIN DIMENSIONS			

SHEET NO. 1 OF 4

THIS DRAWING CONTAINS INFORMATION THAT IS PROPRIETARY TO MOLEX INCORPORATED AND SHOULD NOT BE USED WITHOUT WRITTEN PERMISSION

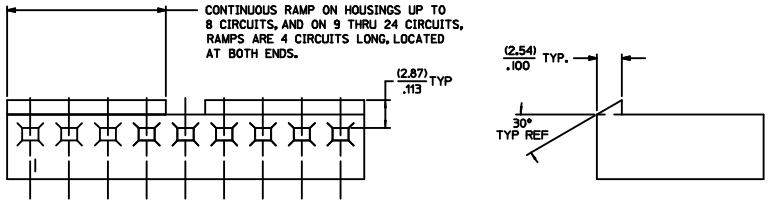

STD. RAMP OPTION CODE "R"

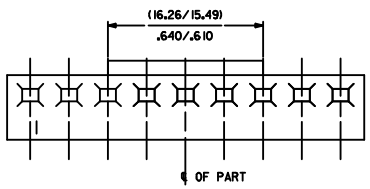

SELECTIVE RAMP OPTION CODE "C"

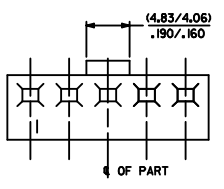

SELECTIVE RAMP OPTION CODE "B"

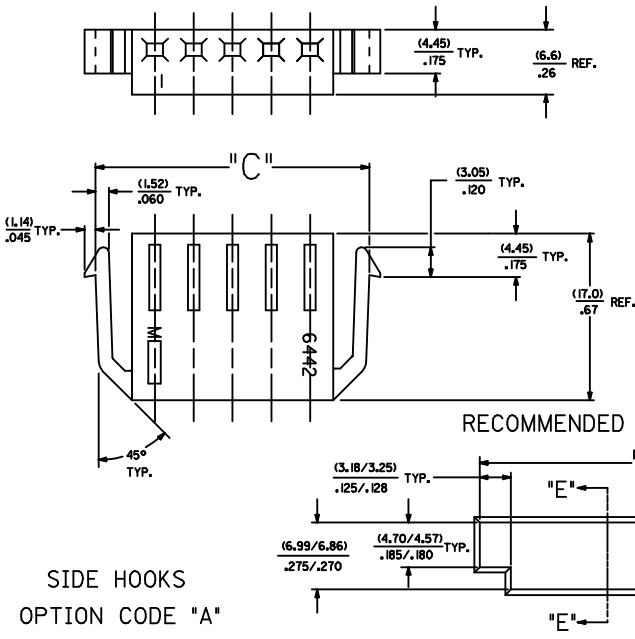

SIDE HOOKS OPTION CODE "A"

RECOMMENDED (2.03)/.080 THICK PANEL OPENING.

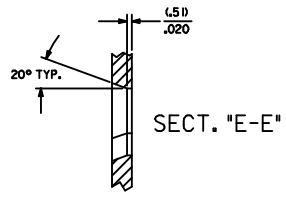

SECT. "E-E"

NO. OF CKT'S.	DIM. "C"	DIM. "D"
2	(16.48/15.60) .643/.614	(15.47/15.34) .609/.604
3	(20.45/19.56) .805/.770	(19.43/19.30) .765/.760
5	(28.37/27.48) 1.117/1.082	(27.36/27.23) 1.077/1.072

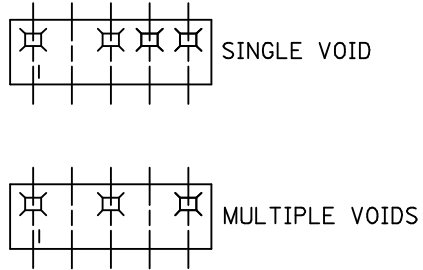

MOLDED VOIDS  
SEE LEGEND ON SHT. 1  
SEE CHART FOR VOID CKT. LOCATIONS

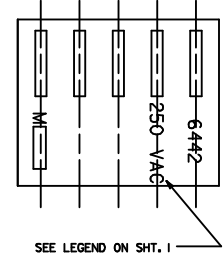

OPT. VOLTAGE RATING

NOTE 10 ADDED IEC NO: IUP2018-0013 DRAWINGS CHYKD APPR: SHWARG 2017/07/28	QUALITY SYMBOLS	GENERAL TOLERANCES (UNLESS SPECIFIED)	DIMENSION STYLE	SCALE	DESIGN UNITS	THIRD ANGLE PROJECTION	
	∇=0 ∇=0 ∇=0	mm INCH 4 PLACES ± .010 3 PLACES ± .010 2 PLACES ± 0.25 ± .014 1 PLACE ± 0.36 ± .014 0 PLACE ± .010 ± .014	MM/IN	---	INCH	DRAWN BY POLGAR DATE 1986/12/05 CHECKED BY DATE PATEL 1986/12/05 APPROVED BY DATE LENZ 1986/12/05	TITLE KK (3.96)/156 TRIFURCON CRIMP TERMINAL HOUSING 6442 SERIES molex MATERIAL NO. SEE CHART DOCUMENT NO. SD-6442
	ANGULAR ±1/2° DRAFT WHERE APPLICABLE MUST REMAIN WITHIN DIMENSIONS	SIZE D THIS DRAWING CONTAINS INFORMATION THAT IS PROPRIETARY TO MOLEX INCORPORATED AND SHOULD NOT BE USED WITHOUT WRITTEN PERMISSION	SHEET NO. 2 OF 4				

	20	19	18	17	16	15	14	13	12	11	10	9	8	7	6	5	4	3	2	1	
	<b>6442-N**</b>			<b>6442-RN**</b>			<b>6442-RN**</b>			<b>6442-RND**</b>			<b>6442-BN**</b>			<b>6442-CN**</b>					
	PART NO.	ENG. NO.	VOIDS	PART NO.	ENG. NO.	VOIDS	PART NO.	ENG. NO.	VOIDS	PART NO.	ENG. NO.	VOIDS	PART NO.	ENG. NO.	VOIDS	PART NO.	ENG. NO.	VOIDS	PART NO.	ENG. NO.	VOIDS
	26-03-3011	6442-1-Z		26-03-4011	6442-R1-Z					26-03-7021	6442-R1D-Z										
	26-03-3021	6442-2-Z		26-03-4020	6442-R2-Z					26-03-7031	6442-R2D-Z										
	26-03-3031	6442-3-Z		26-03-4030	6442-R3-Z					26-03-7041	6442-R3D-Z										
	26-03-3041	6442-4-Z		26-03-4041	6442-R4-Z						6442-R4D-Z										
	26-03-3051	6442-5-Z		26-03-4050	6442-R5-Z						6442-R5D-Z										
	26-03-3061	6442-6-Z		26-03-4061	6442-R6-Z						6442-R6D-Z										
	26-03-3071	6442-7-Z		26-03-4070	6442-R7-Z					26-03-7071	6442-R7D-Z										
	26-03-3081	6442-8-Z		26-03-4081	6442-R8-Z						6442-R8D-Z										
	26-03-3091	6442-9-Z		26-03-4090	6442-R9-Z					26-03-7091	6442-R9D-Z										
	26-03-3101	6442-10-Z		26-03-4101	6442-R10-Z						6442-R10D-Z										
	26-03-3111	6442-11-Z		26-03-4111	6442-R11-Z						6442-R11D-Z										
	26-03-3121	6442-12-Z		26-03-4121	6442-R12-Z					26-03-7121	6442-R12D-Z										
	26-03-3131	6442-13-Z		26-03-4131	6442-R13-Z						6442-R13D-Z										
	26-03-3141	6442-14-Z		26-03-4141	6442-R14-Z						6442-R14D-Z										
	26-03-3151	6442-15-Z		26-03-4151	6442-R15-Z						6442-R15D-Z										
	26-03-3161	6442-16-Z		26-03-4161	6442-R16-Z						6442-R16D-Z										
	26-03-3171	6442-17-Z		26-03-4171	6442-R17-Z					26-03-7171	6442-R17D-Z										
	26-03-3181	6442-18-Z		26-03-4181	6442-R18-Z						6442-R18D-Z										
	26-03-3191	6442-19-Z		26-03-4191	6442-R19-Z						6442-R19D-Z										
	26-03-3201	6442-20-Z		26-03-4201	6442-R20-Z						6442-R20D-Z										
	26-03-3211	6442-21-Z		26-03-4211	6442-R21-Z						6442-R21D-Z										
	26-03-3221	6442-22-Z		26-03-4221	6442-R22-Z						6442-R22D-Z										
	26-03-3231	6442-23-Z		26-03-4231	6442-R23-Z						6442-R23D-Z										
	26-03-3241	6442-24-Z		26-03-4241	6442-R24-Z						6442-R24D-Z										
		6442-15-B	2	26-03-4043	6442-R4-C	3				26-03-7042	6442-R4D-B	2									
		6442-9-B	2	26-03-4055	6442-R5-E	5				26-03-7072	6442-R7D-C	3									
		6442-12-F	6	26-03-4065	6442-R6-E	5				26-03-7092	6442-R9D-B	2									
		6442-7-51	1,7	26-03-4086	6442-R8-F	6				26-03-7093	6442-R9D-E	5									
		6442-9-51	1,9	26-03-4097	6442-R9-G	7				26-03-7122	6442-R12D-E	5									
		6442-9-52	2,9	26-03-4108	6442-R10-H	8				26-03-7172	6442-R17D-E	5									
		6442-8-B	2	26-03-4120	6442-R12-J	10															
		6442-8-F	6	26-03-4157	6442-R15-G	7															
		6442-10-D	4	26-03-4073	6442-R7-C	3															
		6442-5-B	2	26-03-4094	6442-R9-D	4															
		6442-10-B	2	26-03-4096	6442-R9-F	6															
		6442-5-C	3	26-03-4092	6442-R9-B	2															
		6442-13-B	2	26-03-4064	6442-R6-D	4															
		6442-11-E	5	26-03-4075	6442-R7-E	5															
				26-03-4095	6442-R9-E	5															
				26-03-4085	6442-R8-E	5															
				26-03-4072	6442-R7-B	2															
				26-03-4063	6442-R6-C	3															
				26-03-4062	6442-R6-B	2															
				26-03-4125	6442-R12-E	5															
				26-03-4123	6442-R12-C	3															
				26-03-4076	6442-R7-F	6															
				26-03-4129	6442-R12-1	9															
				26-03-4143	6442-R14-C	3															
				26-03-4093	6442-R9-C	3															
				26-03-4054	6442-R5-D	4															
				26-03-4052	6442-R5-B	2															
				26-03-4103	6442-R10-C	3															
				26-03-4042	6442-R4-B	2															
				26-03-4106	6442-R10-F	6															
					6442-R12-F	6															
				26-03-4112	6442-R11-B	2															
					6442-R13-B	2															
				26-03-4175	6442-R17-E	5															
				26-03-4102	6442-R10-B	2															
				26-03-4032	6442-R3-B	2															
				26-03-4082	6442-R8-B	2															
					6442-R7-51	1,7															
					6442-R9-51	1,9															
				26-03-4099	6442-R9-52	2,9															
				26-03-4149	6442-R14-M	13															
					6442-R4-A	1															
				26-03-4152	6442-R15-N	14															
					6442-R10-51	1,10															
				26-03-4083	6442-R-08-C	3															

<b>UPDATE TITLE</b> EC NO. UCF2009-3148 DRWNK/PPER CHKD/SSOUSEK APPR/FSM TH 2009/07/13 2009/07/13 2009/08/05	<b>QUALITY SYMBOLS</b> 	<b>GENERAL TOLERANCES (UNLESS SPECIFIED)</b>		<b>DIMENSION STYLE</b> MM/IN		SCALE ---	DESIGN UNITS INCH	THIRD ANGLE 
		4 PLACES # --- # --- 3 PLACES # --- # --- 2 PLACES # --- # --- 1 PLACE # --- # ---	mm INCH	DATE 1986/12/02	DATE 1986/12/02	<b>KK (3.96)/156 TRIFURCON CRIMP TERMINAL HOUSING 6442 SERIES</b>		
		ANGULAR ±1/2°	APPROVED BY LENZ DATE 1986/12/02	<b>MOLEX INCORPORATED</b>				
		DRAFT WHERE APPLICABLE MUST REMAIN WITHIN DIMENSIONS	MATERIAL NO. <b>SEE CHART</b>	DOCUMENT NO. SD-6442	SHEET NO. 3 OF 4			