

News & Highlights

LINOS Catalog Supplement



Company Profile

As a proud member of Excelitas Technologies, Qioptiq designs and manufactures photonic products and solutions that serve a wide range of markets and applications in the areas of medical and life sciences, industrial manufacturing, defense and aerospace, and research and development.

Qioptiq benefits from having integrated the knowledge and experience of Avimo, Gsänger, LINOS, Optem, Point Source, Rodenstock, Spindler

& Hoyer and others. In October 2013, Qioptiq was acquired by Excelitas Technologies Corp., a global technology leader focused on delivering innovative, customized solutions to meet the lighting, detection and other high-performance technology needs of OEM customers. The combined companies have approximately 6,700 employees in North America, Europe and Asia, serving customers across the world.

Visit www.excelitas.com for more information.

1877 1898 1966 1969 1984 1991 1996

RODENSTOCK

Rodenstock
founded

 **SPINDLER
& HOYER**

Spindler & Hoyer
founded

Pilkington PE
Ltd. founded,
which later
becomes
THALES Optics

Gsänger

Gsänger
Optoelektronik
founded

 **OPTEM
INTERNATIONAL**

Optem
International
founded

 **POINT
SOURCE**

Point Source
founded

LINOS

LINOS founded
through the merger
of Spindler & Hoyer,
Steeg & Reuter
Präzisionsoptik,
Franke Optik and
Gsänger Optoelektronik



BIOMEDICAL



CONSUMER PRODUCTS

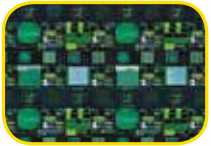

SEMICONDUCTOR



SCIENTIFIC & ANALYTICAL



INDUSTRIAL



DEFENSE & AEROSPACE

Content

Optics & Optical Systems

Volume Dispersion Plates (Opaque Diffuser)	4
Achromats	5
Neutral Density Filters	6
Thin Film Polarizers	7
LINOS F-Theta-Ronar Lenses	8
LINOS Motorized Beam Expanders	10
Optem® FUSION Lens System	11

Capabilities in Optics

Micro Optics	12
Thin Films	14
Diamond Turning and Milling	17

Optics Software

Winlens™ 3D	18
-------------	----

Magneto- and Electro-Optics

Faraday Isolators	20
Pockels, Laser Modulators and DIV20 Amplifier	22

Mechanics

Microbench Sets	24
Tube System C	25
SPCM Connector Kits	26
fle.X-Plate	26
Linear Stages	28
X95 Profile System	30

Lasers

iFLEX-iRIS - Compact, Single-Wavelength Laser Series	32
iFLEX-Agile Series CW-OPO	33
REO Helium-Neon Lasers	34

2000



Rodenstock Präzisionsoptik acquired by LINOS

2001



AVIMO Group acquired by THALES

2005

Qioptiq founded as THALES sells High Tech Optics Group

2006 / 2007



Qioptiq acquires LINOS and Point Source as "members of the Qioptiq group"

2010



The new Qioptiq consolidates all group members under one brand

2013

Qioptiq is acquired by Excelitas Technologies



OPTICS Excellent Performance

With 120 years of experience in optics manufacturing, our comprehensive product range and continuous development of innovative production processes, you can be confident that we have the right components for all of your precision optical requirements in science and industry. High-quality materials and the tightest possible production tolerances ensure the excellence and precision of all our product lines.



We offer singlets, achromats, plano, micro-optic components and polarization optics, zoom optics, complex lens assemblies and machine vision lenses. Our coatings cover the spectral range from DUV to infrared and encompass a constantly expanding array of anti-reflective and mirror coatings. WinLens 3D, our simulation software for designing optical systems, is under continuous development to support you in designing and developing your optical systems for optimal performance.

4

New

Volume Dispersion Plates (Opaque Diffuser)



New opaque optical diffuser plates made from Heraeus HIGH PURITY FUSED SILICA OPAQUE OPTICAL DIFFUSER MATERIAL HOD500. These high-quality diffuser plates contain uniform micro-bubble scattering centers for enhanced diffusion performance. HOD500 is utilized for several optical and industrial applications and also in space applications.

- Two standard diameters in stock. Further custom dimensions and tolerances for higher quantities possible on request.
- Large applicable wavelength range from UV, VIS, NIR to IR benefiting from fused silica transmission properties (high power applications)
- Specified Gegenbauer Parameters for diffusion simulations
- High MECHANICAL, THERMAL and CHEMICAL stability (suitable for calibration purposes in spectroscopy also in harshest environments)
- Lambertian scattering behavior
- Easy cleaning (no open porosity)

Applications

- Photometry
- Diffusing laser beam (e.g. for measuring power)
- Attenuating light beams
- Homogenizing light sources (e.g. LEDs)
- White balance
- Cladding of integrating spheres
- Calibration in spectroscopy

Product	Diameter (mm)	Material	Thickness d (mm)	Wavelength range	Tolerance thickness (mm)	Part No.
Volume dispersion plate HOD; D=22.4; d=0.5	22.4	High Purity Fused Silica	0.5	UV to IR	0.05	G390034000
Volume dispersion plate HOD; D=50; d=0.5	50	High Purity Fused Silica	0.5	UV to IR	0.05	G390035000

Achromats

Highlight

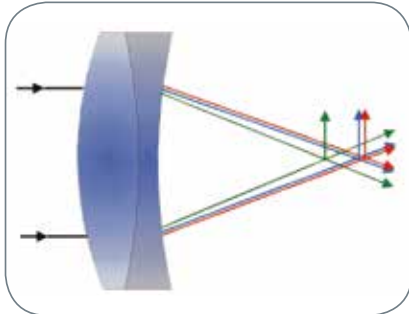

Achromat with a crown glass and a flint glass lens

An achromat with a positive refractive power consists of a convex crown glass lens with low dispersion (color splitting) and a concave flint glass lens with a high dispersion.

The lenses are matched such that the variation of the focus position of the overall system is minimized for two selected wavelengths. A modern chromatic (color) correction of the focus position is calculated for the Fraunhofer lines C' (479.9914 nm) and F' (643.8469 nm). The remaining variation of the focus position (secondary spectrum), e.g. to the e-line (546.074 nm), is typically below 0.1% of the focal length.

In addition, the spherical aberration can be minimized by suitable geometry and material selections. Our achromats are especially well corrected against spherical aberration and are therefore very good for monochrome applications for optimum focusing and/or collimating with minimum wave front deformation, e.g. of laser light.

In the design of our achromats, special attention was paid to the coma correction close to the axis (observance of the Abbe's sine conditions). This type of correction makes the system insensitive to slight tilting. This way, small, extended objects can be mapped very well.

All achromats are laser-centered and therefore have an excellent alignment of the center of curvature (optical axis) to the edge of the achromat. In combination with high demands on the surface shape, this ensures a constant high imaging quality. This optical imaging performance is subject of strict quality control. Typical wavefront deformations are in a range between $\lambda/4$ and $\lambda/10$.

- Minimal longitudinal chromatic aberration
- Minimal spherical aberration
- Minimal wavefront distortion
- Tight focal length tolerance
- Broadband anti-reflection coated with ARB2 VIS

Categories

- Unmounted with \varnothing from 3 up to 100 mm
- Mounted with \varnothing from 3 up to 31.5 mm
- Focal lengths from 3 up to 1000 mm

Your benefit

- Large portfolio of over 100 standard achromats
- Direct delivery from stock
- Detailed information can be found in the database of our Optics Software WinLens™ 3D (see page 18)
- Mounted achromats suitable for our Microbench and Nanobench Systems, respectively

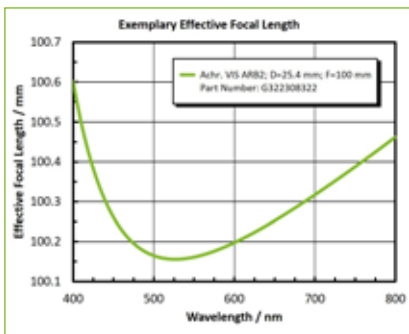

Wavelength depended exemplary effective focal length of an achromat in the visible wavelength region.

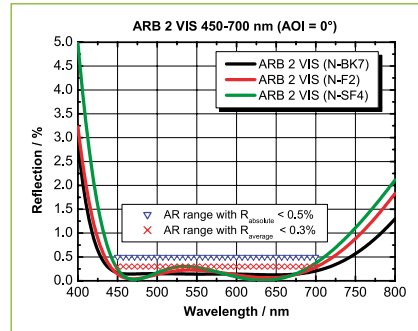

ARB2 Broadband-anti-reflective coating for VIS, Transmission for 450-700 nm > 99 %

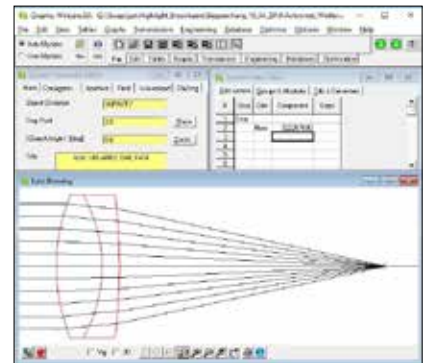

An optical simulation of a standard achromat in WinLens™ 3D: Focusing of a collimated light beam.

Standard Plus

- Customized achromats with specific materials or sizes on request.
- For smaller dimensions with diameters < 3 mm take a look at our Micro Optics capabilities on page 12.





Neutral Density Filters



Attenuate polychromatic light without altering its spectral distribution.

















Transmittance $T = \Phi_t / \Phi_0$
 Optical density $D = \log 1 / T$

- Metallic films vacuum-evaporated onto glass substrates
- For wavelengths from 400 nm up to 2000 nm
- Hard
- Durable
- Firmly adhering
- Mounted and unmounted versions available
- Mounted types fit to Microbench  or Nanobench 

Standard Plus

Custom items (different materials, dimensions, or optical densities) available for higher quantities upon request.

Neutral-density filters, mounted versions

Mount	Ø (mm)	Transmission T (%)	T	Optical density D	Tolerance optical density	Part No.
 Mount N, clear Ø 11.5 mm	12.7	50	0.5	0.3	±0.03	G052501000
 Mount N, clear Ø 11.5 mm	12.7	40	0.4	0.4	±0.04	G052509000
 Mount N, clear Ø 11.5 mm	12.7	20	0.2	0.7	±0.07	G052502000
 Mount N, clear Ø 11.5 mm	12.7	10	0.1	1.0	±0.1	G052503000
 Mount N, clear Ø 11.5 mm	12.7	5	0.05	1.3	±0.1	G052504000
 Mount N, clear Ø 11.5 mm	12.7	2	0.02	1.7	±0.2	G052505000
 Mount N, clear Ø 11.5 mm	12.7	1	0.01	2.0	±0.2	G052506000
 Mount N, clear Ø 11.5 mm	12.7	0.1	0.001	3.0	±0.5	G052507000
 Mount CL, clear Ø 21.4 mm	22.4	50	0.5	0.3	±0.03	G063460000
 Mount CL, clear Ø 21.4 mm	22.4	40	0.4	0.4	±0.04	G063468000
 Mount CL, clear Ø 21.4 mm	22.4	20	0.2	0.7	±0.07	G063461000
 Mount CL, clear Ø 21.4 mm	22.4	10	0.1	1.0	±0.1	G063462000
 Mount CL, clear Ø 21.4 mm	22.4	5	0.05	1.3	±0.1	G063463000
 Mount CL, clear Ø 21.4 mm	22.4	2	0.02	1.7	±0.2	G063464000
 Mount CL, clear Ø 21.4 mm	22.4	1	0.01	2.0	±0.2	G063465000
 Mount CL, clear Ø 21.4 mm	22.4	0.1	0.001	3.0	±0.5	G063466000

 /  In mount fitting directly to Nanobench / Microbench

Application



Application example for our Neutral density filters:

A selection of 5 different neutral density filters mounted in a LINOS Microbench construction. By swiveling the filters in and out 23 different options of attenuation up to 7 orders of magnitude are possible.

You can buy this complete component set: Q-Set Filter Cascade, Part-No. G060409000

Thin Film Polarizers



- Special beamsplitter coatings yield highly polarized transmitted beams
- No angular or lateral deflection of transmitted beams
- Fits to Microbench with clamp holder
- Broadband coated with ARB2
- Combine extreme spectral bandwidth with superb extinction ratio and transmittance

- $T_p > 90\%$
- Extinction ratio transmission $> 10,000:1$ ($\Phi_{Tp} : \Phi_{Ts}$) at $\pm 2^\circ$
- Less than $\lambda/4$ wavefront distortion at 633 nm
- 8° angular beam deflection tolerance
- Damage thresholds: $> 2 \text{ kW/cm}^2$ cw (488/514 nm)
- Damage thresholds: $> 200 \text{ mJ/cm}^2$ for pulses of 10 ns (1064 nm)
- Damage thresholds: $> 28 \text{ mJ/cm}^2$ for pulses of 280 fs (850 nm, 20 Hz)

Application



By rotating the input polarization of a laser beam with a retardation plate, the output intensity after propagation through the Thin Film Polarizer can be varied continuously.

You can buy these Variable Attenuator Q-Sets consisting of all shown components. We deliver different sets optimized for the wavelengths 488, 532, 633 and 780 nm.

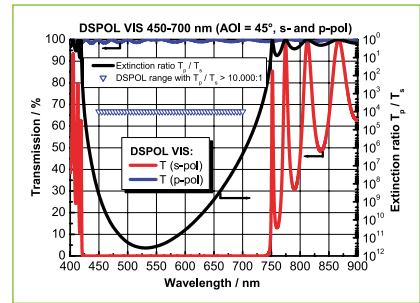

Example: DSPOL VIS for 450-700 nm (AOI = 45°)

Dimensions h=L1=L2 (mm)	Wavelength range (nm)	Tolerance h (mm)	Tolerance L1=L2 (mm)	Part No.
5	390-480	-0.075	±0.2	G335731000
7	450-1050	-0.09	±0.2	G335742000
10	450-1050	-0.09	±0.2	G335743000
12.5	450-1050	-0.11	±0.2	G335745000
16	450-1050	-0.11	±0.3	G335746000
20	450-1050	-0.13	±0.4	G335748000
25	450-1050	-0.13	±0.4	G335749000
5	450-700	-0.075	±0.2	G335711000
7	450-700	-0.09	±0.2	G335712000
10	450-700	-0.09	±0.2	G335713000
12.5	450-700	-0.11	±0.2	G335715000
16	450-700	-0.11	±0.3	G335716000
20	450-700	-0.13	±0.4	G335718000
25	450-700	-0.13	±0.4	G335719000
5	750-1100	-0.075	±0.2	G335721000
7	750-1100	-0.09	±0.2	G335722000
10	750-1100	-0.09	±0.2	G335723000
12.5	750-1100	-0.11	±0.2	G335725000
16	750-1100	-0.11	±0.3	G335726000
20	750-1100	-0.13	±0.4	G335728000
25	750-1100	-0.13	±0.4	G335729000
5	1100-1700	-0.075	±0.2	G335751000
7	1100-1700	-0.09	±0.2	G335752000
10	1100-1700	-0.09	±0.2	G335753000
12.5	1100-1700	-0.11	±0.2	G335755000
20	1100-1700	-0.13	±0.4	G335758000

LASER MATERIAL PROCESSING High Quality Engineering

Benefit from over 30 years of experience in the development of optical systems for laser material processing! Our broad selection of manual and motorized beam expanders and comprehensive range of LINOS F-Theta-Ronar and Focus-Ronar lenses are engineered to meet the most stringent requirements. We will serve you from development and prototyping to volume production. During the full lifetime of your product we are your partner for your OEM needs.

Characteristics of F-Theta Lenses

F-Theta lenses have two main characteristics. When a beam is deflected by a scanning mirror in front of a lens, the scanned distance is proportional to the scanning angle. Secondly the focus position over the entire scan field is always in the same plane.

The extreme versatility of lasers as a tool creates a broad market for focusing systems. F-Theta-Ronar lenses are used in combination with mirror scanning systems. High-quality LINOS F-Theta-Ronar lenses are designed to achieve consistent results over the entire scan field and are built for a wide range of applications:

- Drilling and fine cutting of metals and ceramics (e.g. micro drilling in PCBs)
- Plastic welding (e.g. fusion of plastic materials without additional materials)
- Structuring or perforating of metallic and non-metallic materials (e.g. solar cells, glass)
- Marking (e.g. of smart cards, ICs, printing plates, in-glass, dashboard designs in the automotive industry)
- Cleaning with laser pulses for careful treatment of industrial products (e.g. wafers) as well as restoration projects (e.g. monuments).

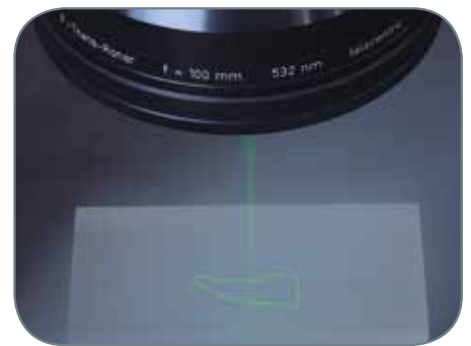

LINOS F-Theta-Ronar Lenses for Microstructuring

Thanks to the telecentric design of our short-focal-length lenses, the laser beam irradiates the image plane almost perpendicularly, even in the edge of the scan field. The small spot sizes and the telecentric design makes them ideal for high precision applications like microstructuring of glass and semiconductor materials, finest markings or precise drilling of holes. At present, lenses with a focal length of 70mm or 100mm are available for the 340-360nm, 515-540nm and 1030-1080nm wavelength ranges.

- Fused-silica designs
- Low-absorption (<20ppm at 1064nm; <30ppm at 532nm) or broadband (UV) coating ; T>96%
- Laser-damage threshold coating up to 4J/cm² at 355nm, 6ns, 100Hz;
- Laser-damage threshold coating up to 20J/cm² at 532nm, 8ns, 100Hz and 0.6J/cm² at 515nm, 204fs, 50kHz
- Laser-damage threshold coating up to 40J/cm² at 1064nm, 12ns, 100Hz and 0.9J/cm² at 1030nm, 291fs, 5kHz
- Includes interchangeable fused silica protective glasses
- Screw tread M85x1



Wavelength (nm)	Focal length (mm)	Scan field (mm ²)	Max. scan angle $\pm\theta_{x,y}$ (°)	Beam diameter (mm)	Spot diameter (μm)	Max. telecentric error (°)	Mirror distances m1/m2 (mm)	Working distance (mm)	Part No.
340-360	70	28 x 28	±11.3	10	5	0.8	13/19	92.5	4401-576-000-21
1030-1080	70	26 x 26	±10.9	14	10	1.8	17/17	87.5	4401-551-000-26
515-540	100	43 x 43	±12.2	14	9	1.7	17/28	138.5	4401-547-000-26
1030-1080	100	43 x 43	±12.2	14	15	2.1	17/28	137.0	4401-561-000-26

LINOS F-Theta-Ronar Lenses for Plastic Welding

These new mid-IR range fused silica lenses with a 1900-2000nm coating are suitable for a variety of applications, such as polymer welding, 3D structuring, and selective laser etching of glass and silicon. Further areas of application are laser processes in the semiconductor industry, micro-machining as well as in ceramics and plastics processing.

- Fused-silica designs
- Transmission >95%
- Includes interchangeable fused silica protective glasses
- Screw thread M85x1



Wavelength (nm)	Focal length (mm)	Scan field (mm ²)	Max. scan angle ±0 _{x,y} (°)	Beam diameter (mm)	Spot diameter (μm)	Mirror distances m1/m2 (mm)	Working distance (mm)	Part No.
1900-2000	265	177 x 177	±19.3	10	94	13/30	328.0	4401-588-000-21
1900-2000	354	214 x 214	±17.7	14	93	17/29	457.5	4401-569-000-21
1900-2000	437	296 x 296	±19.4	14	120	17/30	526.2	4401-568-000-21

LINOS F-Theta-Ronar Lenses for Additive Manufacturing and Metalworking

Thanks to their large focal length of 420mm, these lenses allow scan fields up to 251mm x 251mm. This makes them ideal for additive manufacturing applications. Because of the low-absorption coating and an extremely small thermal focus shift, they are perfectly suited for high-power applications such as metal welding or cutting. They are also ideal for ultra-short-pulse applications and therefore perfect for semiconductor requirements.

- Fused-silica designs
- Low-absorption coating (<20ppm at 1064nm and < 30ppm at 532nm); T>96%
- Laser-damage threshold coating up to 20J/cm² at 532nm, 8ns, 100Hz and 0.6J/cm² at 515nm, 204fs, 50kHz
- Laser-damage threshold coating up to 40J/cm² at 1064nm, 12ns, 100Hz and 0.9J/cm² at 1030nm, 291fs, 5kHz
- Includes interchangeable fused silica protective glasses
- Screw thread M85x1



Wavelength (nm)	Focal length (mm)	Scan field (mm ²)	Max. scan angle ±0 _{x,y} (°)	Beam diameter (mm)	Spot diameter (μm)	Mirror distances m1/m2 (mm)	Working distance (mm)	Part No.
515-540	420	251 x 251	±17.1	14	29	17/24	498.6	4401-590-000-26
1030-1080	420	259 x 259	±17.7	14	59	17/30	510.9	4401-508-000-26

LINOS F-Theta-Ronar Lenses for a Variety of Tasks

The new fused silica lenses with focal lengths of 160mm / 163mm for wavelength 515-540nm and 1030-1080nm are relatively new to the market but they are already proving to be one of its most versatile lenses available. They are optimized for entry apertures from 14 to 20mm (1/e² truncated) and can be operated with both high-power and ultra-short pulse lasers.

- Fused-silica designs
- Low-absorption coating (<20ppm at 1064nm and < 30ppm at 532nm); T>96%
- Laser-damage threshold coating up to 20J/cm² at 532nm, 8ns, 100Hz and 0.6J/cm² at 515nm, 204fs, 50kHz
- Laser-damage threshold coating up to 40J/cm² at 1064nm, 12ns, 100Hz and 0.9J/cm² at 1030nm, 291fs, 5kHz
- Includes interchangeable fused silica protective glasses



Applications

- Additive manufacturing
- Welding utilizations
- Marking • Micro cutting

10

Wavelength (nm)	Focal length (mm)	Scan field (mm ²)	Max. scan angle ±θ _{x,y} (°)	Beam diameter (mm)	Spot diameter (μm)	Mirror distances m1/m2 (mm)	Working distance (mm)	Part No.
515 -540	160	83 x 83	±15.2	14	12	17/23	215.8	4401-587-000-26
1030-1080	163	85 x 85	±15.2	14	23	17/23	219.3	4401-589-000-26

LINOS Motorized Beam Expanders 1x-4x

The Motorized Variable Beam Expander 1-4x is a sophisticated next-generation model of our existing variable beam expander. It allows an adaption of the focus diameter, the focal position as well as the spot quality.

Its motorization enables considerably reduced set-up times and higher repetition accuracy. The external control allows for universal and flexible use of the laser light in production processes, with the need of different beam diameters and defocusing of the laser. The magnification range from 1x-4x and the large useable entrance aperture was especial adapted to accommodate modern and current laser sources with bigger laser beam diameters.

- Maintains laser-protection class during readjustment of the beam expander
- 10 individual pre-sets for magnification and divergence
- Software running on the Windows® platform (Win7, Win8, Win10)
- CE and ROHS compliant
- IP 20
- Exit-beam diameter: max. 31 mm
- Pointing stability < 0.5 mrad
- Fast adjustment from 1x to 4x within 7 sec.
- Mechanical interface via high-precision holes 6H7 (recommended) or mounting diameter 39h11
- Different electronic interfaces: SubD9/ RS232, USB 2.0, Phoenix Contact/ RS232
- Baud rate: 9600 bit/sec
- Power input 7-12 V, Phoenix Contact 7-24 V
- Entrance-beam diameter max. = 31 mm / zoom factor



Highest performance

- Continuous variable magnification
- Fused-silica designs
- Continuous variation of exit-beam divergence
- Reduced machine setup times by automatic change of magnification
- Interchangeable protective glass included
- All-in-one design

Wavelength (nm)	Max. entrance-beam diameter at 1/e ² (mm)	PC Interface	Part No.
515 - 540	8	SubD9/ RS232	4401-597-000-20
515 - 540	8	Phoenix Contact/ RS232	4401-597-000-21
515 - 540	8	USB 2.0	4401-597-000-22
1030 - 1080	8	SubD9/ RS232	4401-598-000-20
1030 - 1080	8	Phoenix Contact/ RS232	4401-598-000-21
1030 - 1080	8	USB 2.0	4401-598-000-22

Optem® FUSION Lens System for Shortwave Infrared (SWIR) Applications

The capabilities of field-proven Optem® FUSION Micro-Inspection imaging system, have been expanded to meet the growing need for shortwave infrared (SWIR) sensors that enable next-generation machine vision applications. The lens system now provides true polychromatic imaging performance across the key visible (400nm-700nm), NIR (700nm-1100nm) and SWIR (900nm-1700nm) wavebands.

The new Optem FUSION SWIR Lens system leverages proven mechanics, modularity and interchangeability to provide a singular optical platform that addresses the needs of diverse applications across many industries – without the complexities, long development cycles and costs that can be associated with custom solutions.

To provide high performance and versatile imaging across a large variety of magnifications and working distances, we adapted and carefully optimized a range of our most popular Optem® FUSION components including:

- Lower Objective Lenses, with numerous magnifications and working distances
- 7:1 Zoom Module
- Fixed-Magnification Core Modules
- Camera Tube Lenses with a range of magnification to optimize camera performance
- Beam splitter for critical coaxial illumination support

Not only have the optical coatings and beam-splitters been re-optimized to maximize optical throughput across the SWIR wavelength range, the optical design has been carefully re-engineered resulting in an optical system that maximizes imaging performance ensuring you capture the details necessary for your application to succeed.

Optem® FUSION SWIR features various camera tube lenses and supports all SWIR cameras currently available on the market. Zoom and focus operations can be motorized to enable fully automated inspection solutions.

- NEW Optical design for precision imaging across 700-1700nm waveband
- Modular and interchangeable with existing FUSION optical platform
- Fixed magnification, 7:1 and 12.5:1 Zoom
- Range of working distances and magnifications

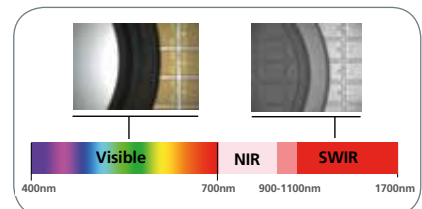

Optem Fusion Lens System: True polychromatic imaging performance across the key Visible, NIR and the SWIR wavebands

Your benefit

- Extreme versatility
- Modular
- Interchangeable
- Ready-to-use
- Ideally when time-to-market is critical

Example



Optem Fusion micro-inspection setup mounted on our X95 profile

SWIR applications

- Silicon inspection
- Advanced fluorescence imaging
- Life sciences
- Forensics
- Geology



Optem Fusion lens system assembly including the new SWIR components

MICRO OPTICS Made in Germany

We utilize a good eye, steady hand and ultra-precise tools to manufacture miniature lenses, some measuring less than 1 millimeter in diameter. As one might imagine, the daily production output for our micro-optics operation fits in the space equivalent to a shoebox. Upon production, we ship these precision lenses all over the world to meet the micro-optic needs of our customers in the medical, analytical instrumentation, automated optical inspection and scientific research sectors.

The production flow covers all work steps of lens production, from grinding and polishing, to coatings up through complex micro assemblies. The components produced are used not only in medical applications such as endoscopy, but also in many industrial fields including metrology and automation technology.

12

Micro Optics, General



- Grinding and polishing of spherical and plano optical components ≥ 0.3 mm from all established optical glasses
- CNC and traditional production technologies
- Surface treatment suitable for laser quality
- Thin film coating of precision optics (AR, filters, mirrors and hydrophobic)
- Lithographic aperture stops and masks
- Optical fine cementing and alignment
- Assembling, testing and documentation
- Narrow tolerances for high end applications, e.g. 3D
- Wide range of Qioptiq test plates available in Zemax OpticStudio TPL
- Special test equipment

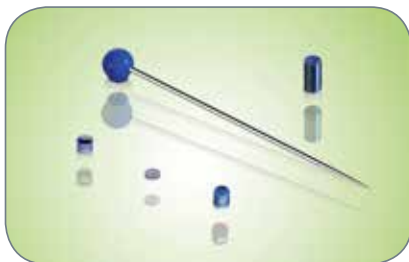

Customized Micro Optical Components

- Spherical lenses, doublets, triplets
- Rod lenses and compact objectives for rigid endoscopes
- Plano optics, e.g. cover glasses
- Optical glasses and fused silica
- Built-to-print according to customer drawing or specification
- From prototype to serial production

Spherical optics

- Lens diameter: 0.3 - 20 mm
- Possible surface quality: ≥ 0.5 fringes
- Possible irregularity: ≥ 0.2 fringes
- Centering error: $\geq 1'$
- Center thickness: up to ± 0.01 mm
- Diameter tolerance: ≥ 0.002 mm

Coating

- Single layer for all wavelengths
- Double layer (V-coating)
- Multi layer for UV to NIR
- Anti-reflective coating (e.g. MgF₂)
- Beamsplitter for specific wavelengths
- Back and front mirrors with Al and Ag
- Filters (e.g. IR-cut)

Cementing

- Diameter ≥ 0.5 mm (smaller diameters on request)
- Doublets – triplets – compact objectives – rod lens systems
- All typical UV and epoxy glues
- Alignment: $\geq 0.5'$

Customized Opto-Mechanical Assemblies

- Development of optical systems according to customer-specific requirements
- Mechanical design
- Coating design
- Prototypes, pre-serial production and serial production
- Testing and documentation

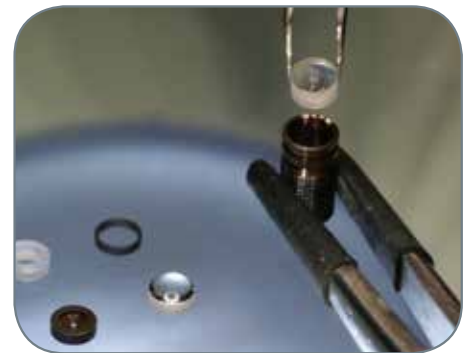

Customized Micro Objectives

- Field of view: up to 190°
- Diameter: ≥ 0.8 mm
- Pinhole diameter: ≥ 0.1 mm ± 0.005 mm
- High precision field stop with chromium layer within the glued surface of the optical component, decentering ± 0.01 mm

HD Micro Objectives



Owed to many years of experience in the field of Chip-On-The-Tip technology, we were able to advance the development and production of new objectives for small image sensors.

All types have an integrated infrared-absorbing-filter and a lithographically generated aperture.

Applications

- Video endoscopes for medical or technical applications
- Cameras for the industrial sector
- Image processing systems

Item Title	Focal length (mm)	F-number	Field of view	Image field of view (diameter) (mm)	Working Distance (mm)	Outer-Ø (mm)	Length (mm)	Back focal length (mm)	Part No.
EAGLE for 1/6"	1.40	6	140	2.70	8	3.2	5.50	1.49	105006900
EAGLE for 1/10"	1.40	6	80	1.84	8	2.4	5.50	1.49	105014900
FALCON for 1/10" 90°	1.17	6	90	1.84	6	1.7	3.25	1.70	201090900
FALCON for 1/10" 110°	0.99	6	110	1.84	6	1.7	3.25	1.90	201110900
FALCON for 1/10" 140°	0.86	6	140	1.84	6	1.7	3.25	1.80	201140900

A closer look

You need more specific information about our Micro optics capabilities and products? Please ask for our new brochure:

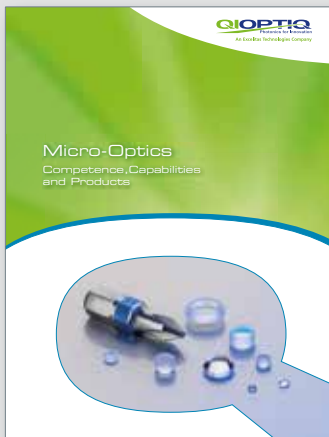

The EAGLE Series objectives, providing pin-sharp image, have originally been developed for endoscopes. Due to the compact size of the CMOS image sensors which produce the HD resolution (1920 x 1080 pixels), each pixel is only 1 – 2 µm (0.001 – 0.002 mm) small. Needless to say, the objective was developed to also work with CCD sensors.

The FALCON objectives for 1/10" image sensors are available in fields-of-view of 90°, 110° and 140°. With a total length of only 5 mm (including back focal distance), the FALCON micro objectives contain a five-part lens system with an integrated infrared-absorbing filter and a lithographically generated aperture.

A significant feature of the FALCON micro objectives is the high MTF, making them ideal for small detector dimensions. These objectives are designed for the nominal object distance of $s_0 = 6$ mm. Each of the objectives can be focused at a respective working distance of 3–50 mm. Within this working distance and at a spatial frequency of 100 lp/mm, the MTF is >30%. Within the nominal object distance, the guaranteed MTF of 135 lp/mm for the near-axis rays is above average.

Another specific feature is the unvignetted image of these objectives, which guarantees an optimal homogeneity of the illumination intensity (means a minimum middle-edge fall-off in brightness), only limited by physical rules.

Thin Films Expertise in Coating

From laser mirrors and filters to beamsplitters and anti-reflective coatings, the extensive range of our coatings can meet your most stringent requirements.

If you can not find the coating that you need for your application among our standard coatings, please contact our experts, they will be happy to work with you in developing a special coating.

With a wide range of production methods and many years of experience, our staff can offer a variety of solutions to find the best way to implement your designs. Our constant quality control ensures you reliability in planning, even for large series.

14

General

Our expertise in coatings extends from the DUV to well into the IR spectral range. The product array includes the following coating types:

- Narrowband and broadband AR coatings
- Dielectric and metallic mirror coatings
- Shortpass and longpass filters (heat protection filter/cold light mirror)
- Beam splitters
- Polarizing filters
- Bandpass filters
- Notch filters (narrowband reflectors)

In addition to conventional PVD and plasma-assisted vapor deposition processes, we have state-of-the-art coating units for ion-beam sputtering and magnetron sputtering as well.



Parameter setting and start of the coating process



Coating unit for plasma assisted vapour deposition



Our coating specialist prepares the coating process

Measurement Technology

Our core competencies include not only the design and application of coatings, but also the testing of coating specifications using all relevant measurement technology. The reflection and transmission of coated and uncoated substrates can be determined in a spectral range from 120 nm to 25 μm , solved for both angle and polarization.

Our measurement equipment includes a DUV spectrometer, several UV-VIS-NIR dual-beam spectrophotometers and an FTIR spectrometer. We can also measure reflection in VIS/NIR on curved surfaces, for example by verifying the homogeneity of the coating all the way to the edge of a lens.

In addition to our photometric measuring instruments, we also have available the following measuring stations for verification of various specifications:

- White-light interferometer to measure surface roughness
- Measuring station for checking surface flatness or transmitted wave front
- Measuring station for scratch and dig analysis
- Various laser measuring stations that can be refitted as needed
- Cavity ring-down measuring station for measuring low loss of dielectric mirrors

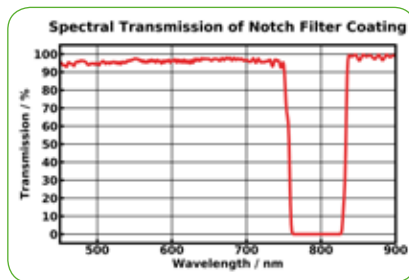

Spectral transmission of an exemplary notch filter coating. The notch has a central wavelength of 794 nm and a spectral width of 67 nm.



High precision measurement equipment: FTIR Spectrometer



UV-VIS-NIR Two-Beam Spectral Photometer

Environmental Tests

Our standard coatings are tested and certified using standardized procedures in accordance with DIN/ISO or MIL standards. This guarantees not only the optical performance of our coatings, but also the stability of the coated optical components under application conditions and a variety of environmental influences.

Our coatings are tested in accordance with the following standards:

- Abrasion resistance: DIN/ISO 9211-4-01 or corresponding MIL standards
- Adhesion resistance: DIN/ISO 9211-4-02 or corresponding MIL standards
- Resistance to solvents in accordance with DIN/ISO 9211-3-12 or corresponding MIL standards
- Resistance to water and salt water deposits in accordance with DIN/ISO 9211-4-04 or corresponding MIL standards

- Stability under environmental conditions (damp heat, cold, dry heat, temperature fluctuation) in accordance with DIN/ISO 9022-2 or corresponding MIL standards

Another important test is the determination of the laser-induced damage threshold (LIDT) of the coating in accordance with EN ISO 21254.

Highlight

Thin Film Polarizer Coating DSPOL VIS-NIR

- For polarizing cube beamsplitters made from two cemented 90°-prisms for the visible and the near infrared spectral range
- Extreme high splitting of polarization of the transmitted beam within a broad spectral range from the visible up to the near infrared range
- Guaranteed extinction ratio within the specified range of polarization (DSPOL-range) for the transmitted beam of $T_p : T_s > 10000 : 1$
- Damage threshold: limiting factor cemented system! Damage threshold $H_{\infty} > 100 \text{ mJ/cm}^2$ at 1064 nm with 11 ns laser pulses (s-on-1), 10 Hz
- Design adaptable within the spectral range from $400 \text{ nm} \leq \lambda \leq 1200 \text{ nm}$
- Substrates: S-NBH 51, N-SF4, or similar

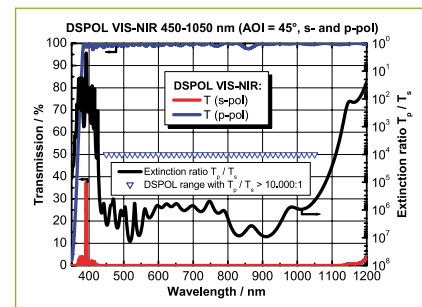

Example: DSPOL VIS-NIR for 450-1050 nm (AOI = 45°)

Highlight

Broadband Anti-Reflective Coating ARB 2 VIS

- Hard and scratch resistant anti-reflective coating to reduce reflection losses and increase transmission for the visible spectral range
- Damage threshold $H_{10} > 10 \text{ J/cm}^2$ at 532 nm with 11 ns laser pulses (s-on-1) at 10 Hz
- AR range typical: 450-700 nm
- Design adaptable in the spectral range of $350 \text{ nm} \leq \lambda \leq 950 \text{ nm}$ and for higher angles of incidence
- Substrates: N-BK7, fused silica or similar

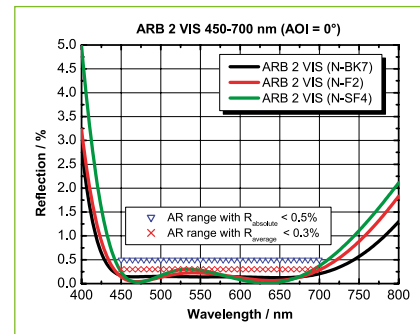

Example: ARB 2 VIS for 450-700 nm (AOI = 0°)

Highlight

UV High-Power Laser Mirror Coating DLHS UV

- Low-loss, hard and scratch resistant laser mirror coating for the UV spectral range
- Damage thresholds $H_{10} > 5 \text{ J/cm}^2$ at 308 nm with 15 ns laser pulses (s-on-1) at 10 Hz
- Also available as dichroic
- Design adaptable in the spectral range of $240 \text{ nm} \leq \lambda \leq 450 \text{ nm}$ and for other angles of incidence
- Substrates: fused silica, CaF2 or similar
- Please specify desired central wavelength λ_0 and AOI (α) when ordering.

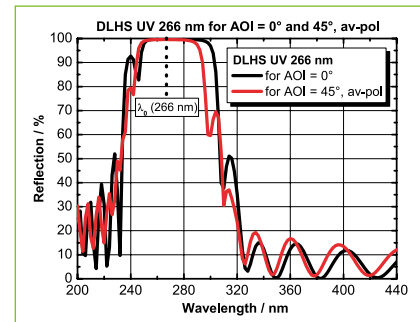

DLHS UV for 266 nm (AOI = 0°) and DLHS UV for 266 nm (AOI = 45°), unpolarized

Highlight

NIR Broadband Beamsplitter Coating TBP NIR

- Low-loss, hard and scratch resistant beamsplitter coating for the near infrared spectral range
- For splitting and combining of beam paths
- Selectable transmission between $10\% \leq T \leq 80\%$
- Damage threshold $H_{10} > 10 \text{ J/cm}^2$ at 1064 nm with 11 ns laser pulses (s-on-1) at 10 Hz
- Design adaptable within the spectral range from $600 \text{ nm} \leq \lambda \leq 1400 \text{ nm}$, for other angles of incidence (AOI) and for certain polarizations
- Substrates: N-BK7, fused silica, or similar
- Please specify desired central wavelength λ_0 and AOI (α) when ordering.

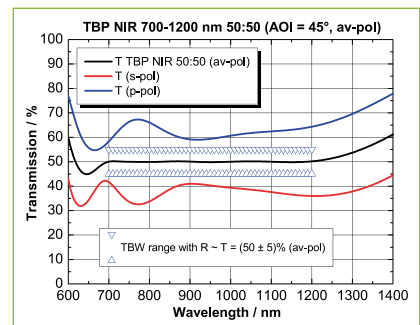

Example: TBP NIR 50:50 for 700-1200 nm (AOI = 45°; unpolarized)

Highlight

Reflective Gold Coating RAU-E

- Front surface mirror gold coating for the IR spectral range up to $25 \mu\text{m}$ with improved environmental characteristics
- Constant high reflection within a broad spectral and angle-of-incidence range without absorption bands
- Average reflection $> 98\%$ in the range of $0^\circ \leq \text{AOI} \leq 60^\circ$, unpolarized
- Abrasion resistant gold coating also on diamond turned or diamond milled aluminium
- Substrates: optical glasses, glass ceramic, diamond-turned Aluminium or Copper, or similar

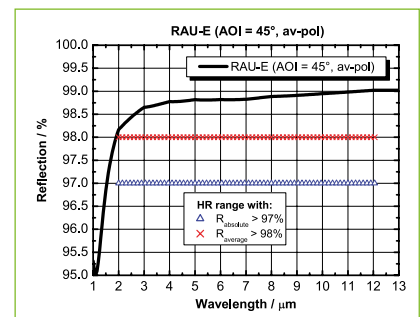

Example: RAU-E (AOI=45°, unpolarized)

DIAMOND TURNING & MILLING

The Highest Precision in Every Shape

Diamond Turning:

Over 30 years of experience, skilled employees and up state-of-the-art equipment contribute to our excellence in manufacturing diamond turned surfaces.

Diamond milling:

Our know-how in high-precision optics and an excellent understanding of material behavior enable us to manufacture plane surfaces of highest quality.



Rotation-symmetric multiple aspherical surface, aluminium.

We manufacture

- Spherical surfaces
- Aspherical surfaces
- Freeform surfaces
- Diffractive structures
- Ultra-precise functional surfaces with fiducials

up to a component size of \varnothing 600 mm x 200 mm (weight max. 30 kg) as directly produced functional parts or as precision mouldings for replication processes.

Diamond Turning

Our machinery

- Moore Nanotech 250UPL, 3 axes
- Moore Nanotech 350FG, 5 axes + milling spindle
- Moore Fast Tool Servo NFTS-6000

Material	Surface deviation down to	Surface roughness down to
Aluminium	$\lambda/10$	2 nm
Non-ferrous metals	$\lambda/10$	3 nm
Steel	3λ	40 nm
PMMA	2λ	5 nm
Topas®/ Zeonex®	2λ	5 nm
Silicon	$\lambda/5$	4 nm
Germanium	$\lambda/10$	2 nm
Ceramics	3λ	n.a.
Zinc Sulphide	$\lambda/5$	4 nm
More materials on request		

Diamond Milling

Our machinery

- 2x LT Ultra Milling Machines SMMC 600 XC

Our know-how

- We manufacture high-precision plane surfaces up to a component size of max. 100 mm x 100 mm x 100 mm.

Material	Surface deviation down to	Surface roughness down to
Aluminium	$\lambda/2$	2 nm
Non-ferrous metals	$\lambda/2$	4 nm
Crystal materials (e.g. KDP, ADP)	λ	4 nm



Rotation-symmetric aspherical surface, PMMA.

Metrology

State-of-the-art equipment combined with the experience of many years in optical metrology guarantee our high quality standards, also for manufacturing freeform surfaces.

Procedure	Machines	Type	Measurement	Accuracy
Tactile	3D-coordinates measuring machines	Zeiss Prismo 7, Contura 0-Inspect	Shape deviation	$0.9 \mu\text{m} + L/400$
	Profile measuring device machines	Form Talysurf PGI 1240	Surface deviation	$0.2 \mu\text{m}$
Non-contact	Interferometrical measurements, if applicable with CGH	Zygo Verifire XPZ 4"	Surface deviation	$\lambda/10$
	White light interferometer	Bruker Contour GTI	Micro roughness	1 nm
	Measuring microscope	Nikon MM-400	Dimensions	$1 \mu\text{m}$

SOFTWARE PACKAGE

WinLens™ 3D

NEW Version

WinLens™ 3D is a powerful, user-friendly lens design software platform for the PC. For over 25 years, Qioptiq has made WinLens™ 3D available to its customers – basing development upon the feedback of users and the needs and experience of our team of skilled designers & educators, in simulation, analysis, optimisation, coating and tolerancing.

The full WinLens suite consists of four individual programs, WinLens™ 3D, Tolerancer, Glass Manager & Material Editor. Upon purchasing the complete software package you will receive the official license code.

The programs are both practical and informative with intuitive interfaces and simple menu structures. They offer many tools, graphs and tables that will help full time optical designers & engineers, researchers, lecturers and students.

- The WinLens suite will run on any Windows PC (7, 8 or 10) with a minimum monitor resolution of 1024x768

18

WinLens™ 3D Basic is a free version with reduced capabilities. Providing the same features as WinLens™ 3D, it does not contain optimisation and ghost analysis.

Complete systems can be build up from a mix of Qioptiq catalog parts and custom elements.

- Graphs and tables can be loaded and positioned as required by user
- Lens drawings, graphs & tables can be cloned and then parameters set individually
- High resolution printouts of graphs
- Detailed manuals
- Extensive help systems

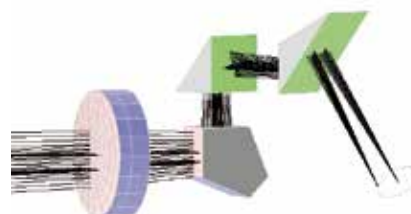

Product	Part No.
Software package WinLens™ 3D Suite	G302020000

The update includes

- Latest Qioptiq catalog components
- Latest Glass data from the main manufacturers
- Thin film coating enhancements:
 - Revised thin film data for Qioptiq AR coatings
 - Support for user defined coatings
 - Significantly improved thin film database display

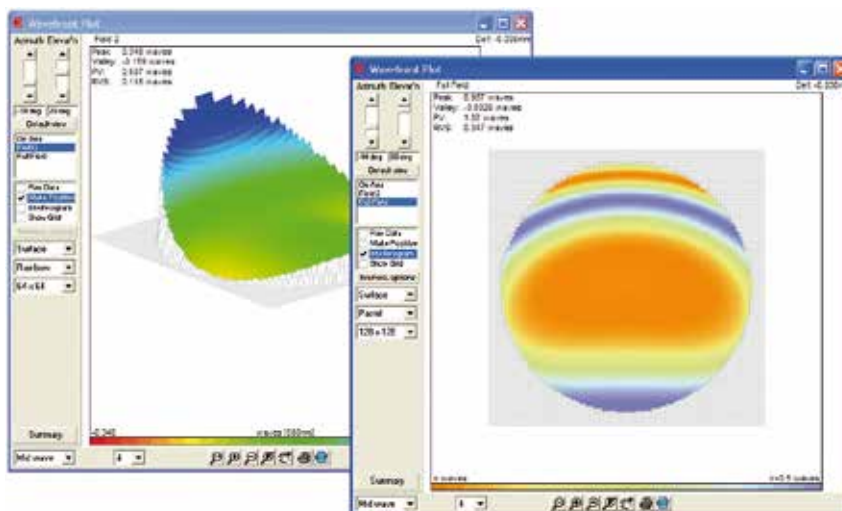

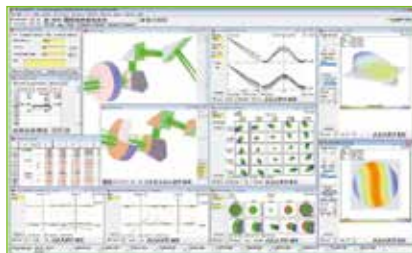

WinLens™ 3D

- Easy setup & extensive analysis of optical systems
- Interactive glass map & other glass finding tools
- Powerful optimization with 'video' replay
- Model zoom systems. Graphs can show selected zooms
- Model 3D systems with easy tilt & decenter
- Simple prism wizard
- Thin film coatings - Qioptiq & custom
- Transmittance, footprint and ghost analysis
- Very fast review of existing systems - single click
- Import/export to third party formats

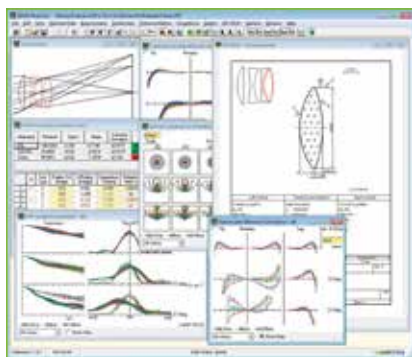

WinLens Tolerancer

- For tolerancing centered (rotationally symmetric) systems
- Models changes in radius, index, separation etc.
- Models tilt, decenter and surface cylinder
- Sensitivity analyses - from Efl & Seidels to Spot diagram & MTF
- Tolerance editors with instant feedback
- Monte Carlo simulations of production runs
- Powerful editors to create ISO 10110 drawings
- Slidable standard dimensions and datum
- Wide range of extra symbols
- Custom preferences
- High resolution printouts

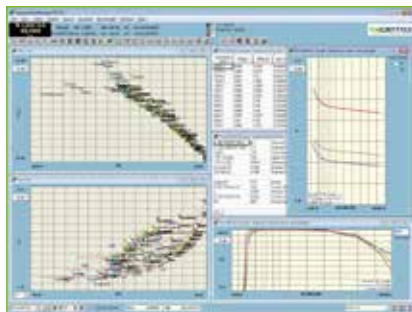

Glass Manager

- Database of optical glasses from the main makers
- Supports user defined materials
- Standard glass maps with custom colour scheme as a "third axis"
- Custom glass map with choice of properties for both axes
- Graphs of refractive index & transmission vs wavelength
- Tables of index, transmission and chemical, mechanical, thermal & other properties
- Powerful glass finding tools for groups of glasses and individual materials
- Custom wavebands – impact all glass maps

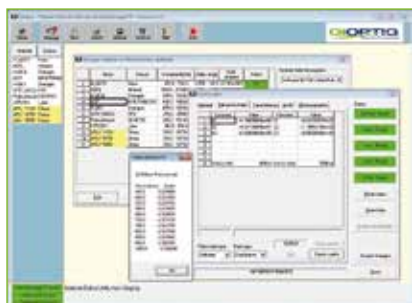

Material Editor

- Utility to create, edit & manage glasses for WinLens™ 3D and Glass Manager
- Create materials from scratch
- Create melt glass derivatives of existing materials
- Import glasses from some third party formats
- Export to WinLens™ 3D and/or Glass Manager

MAGNETO- and ELECTRO-OPTICS High-Quality Products

The combination of our years of experience, intelligent design and sophisticated engineering with computer simulations and complex processing produces the enduring high quality of our products for magneto- and electro-optics. You can depend on the added value that characterizes all Qioptiq components!

We offer LINOS Faraday Isolators both as standard products and as customized solutions for your specific requirements. LINOS Laser Modulators for applications outside of laser cavity are available in many variants to cover a broad range of wavelengths. Our LINOS Pockels Cells are another product group that gives you a wide spectrum of standard products to choose from.

A closer look

The excellent quality of the high-precision LINOS magneto- and electro-optics from Qioptiq is a testament to decades of experience at both Gsänger and Qioptiq. More than 50-year history of these products is marked by immense customer satisfaction, and has established Qioptiq as a leader in laser technology



Dr. Gsänger, founder of Gsänger Optics in Munich, was instrumental in the success of electro-optics in laser technology.

We are happy to accommodate any of our customized product modifications designed to your exacting specifications, as well as for individual requests and small-batch production.

Low-Outgassing Isolators with 3.3 mm Aperture, LO Series

Our extensive experience and innovation in optical solutions for semiconductor manufacturing have led to the first ever Low-Outgassing Faraday Isolator. These Isolators are ideally suited for integration in encapsulated and high-power laser systems in the wavelength range from UV to the NIR. The unique design emits 25-times less volatile organic compounds (VOCs) than conventionally produced isolators.

Optically contacted, fused-silica input and output polarizers ensure high damage threshold while delivering highest isolation of 33 dB and outstanding transmittance of 95% in the NIR and 86% in the UV. They feature a 3.3 mm clear aperture and a patented magnet system, which enables an exceptionally compact design footprint.

- Emitting 25-times less volatile organic compounds (VOC) than conventionally produced isolators
- Sophisticated, low-outgassing design and assembly Isolation ≥ 33 dB, typically 38-42 dB over the entire wavelength range
- Extremely compact package
- Optically contacted polarizers for high damage threshold and long enduring quality
- Rare earth magnet
- Access to blocked beam
- Stable and flexible mounting via four M2 threaded holes on the bottom side and backside
- Custom wavelengths and specifications upon request
- Integrated waveplate optional

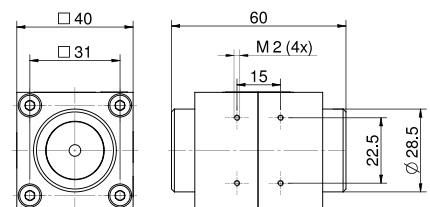

Less is more

These LO versions emit 25-times less volatile organic compounds than usual, combined with highest isolation as well as high damage threshold.

Product	Part No.
FI-405-3SC LO	845110900026
FI-1030-3SC LO	845110100230
FI-1060-3SC LO	845110100231

New

High-Power Isolators with 3.5 and 5 mm Aperture, XP Series

- Suitable for laser powers above 50 W
- Extreme compact design
- Isolation better than 30 dB
- Low thermal lens effect
- Low-absorption magneto-optical crystal
- Strong rare earth magnet
- Mounting: via four M2 threaded holes at the bottom side and at backside
- Damage threshold 8.5 J/cm² at 8 ns 1064 nm
- Custom wavelengths and specifications on request
- Available with integrated wave-plate on request



Product	Part No.
FI-1060-3SC XP	845110900030
FI-1060-5SC XP	845110900029

High power

These Isolators are ideally suited for integration in medium to high-power laser systems (CW laser power $P \geq 50W$) in the wavelength range from red to NIR. The XP Series Isolators are uniquely designed with a low-absorption magneto-optical material that results in significantly lower thermal lens effect and enhanced optical isolation.

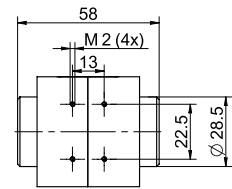
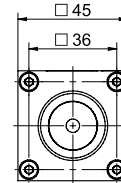
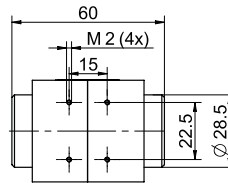
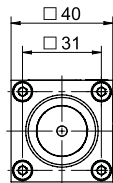
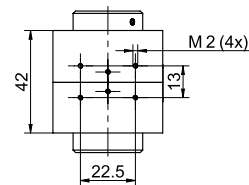
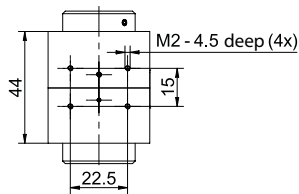

FI-1060-3SC XP

FI-1060-5SC XP

21

Rotatable Isolator Series with 3.5 mm Aperture, RO Series

- Single-stage Faraday Isolator
- Rotatable isolator body (for arbitrary input polarization)
- Compact design
- Mounting option for half-wave plate at the optical output
- Aperture: $\varnothing 3.5$ mm
- Isolation: 32 dB (typically 38 - 42 dB)
- Mounting: via mounting bracket
- Damage threshold: 8.5 J/cm² at 8 ns 1064 nm
- Custom wavelengths and specifications on request
- Available with integrated half-wave plate on request

Product	Part No.
FI-1060-3SC XP	845110900030

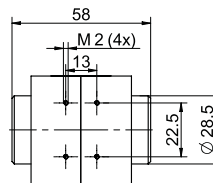
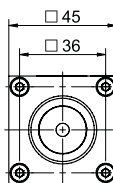
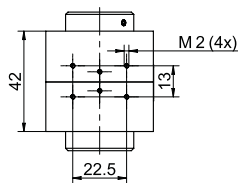

New



Custom option

You need a modified mounting bracket?
Please ask for your own design!

KD*P Pockels Cell 50 Ohm Series

Leveraging extensive experience and innovations in optical solutions for lasers and laser systems for industrial, medical and semiconductor applications, the new transmission line 50 Ohm Pockels Cell provides ultra-fast switching in the nano-second and sub-nano-second range combined with excellent extinction and high transmission in a 50 Ohm impedance matching compact design.

These ultra-fast Pockels Cells are ideally suited for integration in medical laser systems in cases where fast switching, pulse slicing or pulse picking are required.

- KD*P-based pockels cell
- High crystal deuteration (typical): > 98%
- 50 Ohm type Pockels cell for use in transmission line configuration
- Suitable for fast switching and pulse slicing (rise / fall time: < 500 ps possible with suitable high-voltage driver)
- Impedance approx. 50 Ohm (not guaranteed)
- BNC connectors
- Wavefront distortion: < $\lambda/4$ Damage
- Threshold: > 2 GW/cm² at 1064 nm, 12 ns, 1 Hz (typical)
- Crystal diameter: 10 mm
- Anti-reflection coating on crystal: SolGel (SG)



Product	Part No.
LM10 SG HD 50 Ohm 1064 nm	845130100092
LM10 SG HD 50 Ohm 755 nm	845130100093

Get faster

Our ultra-fast switching 50 Ohm Cells, specially designed for medical laser systems, are the ideal pulse slicer to generate sub-ns laser pulses.

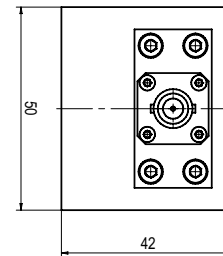
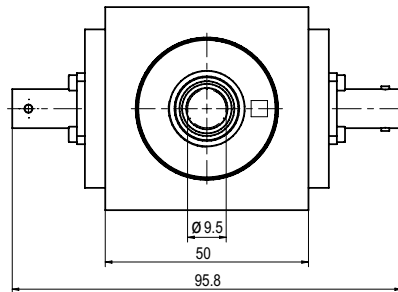

BBO Pockels Cells for High Switching Rates DBBPC HR

The new LINOS Double BBO High-Repetition Pockels Cells (DBBPC HR) enable the fastest possible switching rates available today with > 1.3 MHz performance. Together with the low absorbing BBO crystals the DBBPC HR Pockels Cells are perfectly suited for the next generation of fast regenerative amplifiers and pulse pickers.

- Other specifications on request
- This product is export controlled according to regulation (EC) No. 428/2009, list item 6A005. Shipping is subject to the existence of a valid export license, if necessary.

- BBO Pockels Cell with 2 crystals in optical series
- For high switching rate applications up to 1.3 MHz
- For high average power applications
- Design wavelength 1030 nm (other wavelengths on request)
- Damage threshold @ 1064 nm, 74 ps: > 4 J/cm²
- Reduced switching voltage
- Suitable for quarter- and half-wave mode applications
- For Q-Switching, cavity dumping, regenerative amplifiers and pulse pickers
- All order numbers valid for 1030 nm

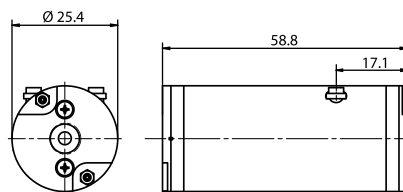

DBBPC 3 HR 1030 nm

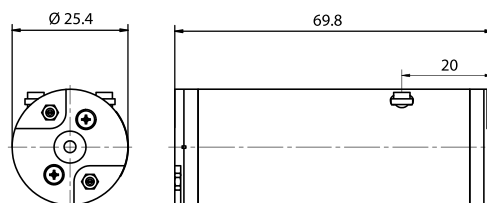

DBBPC 3.5 HR 1030 nm

Product	Part No.
LM10 SG HD 50 Ohm 1064 nm	845130100092
LM10 SG HD 50 Ohm 755 nm	845130100093

Laser Modulators LM 0202

Electro-optical crystals are characterized by their ability to change optical path length in function of an applied external voltage. The crystal orientation of the LM 0202 and LM 0202P modulators has been optimized to minimize the retardation caused by natural birefringence. A special model, LM 0202 PHAS, is available with a crystal configuration that uses all four crystals for phase modulation.

- Different versions: universal modulator, intensity modulator (P) with thin film polarizer, phase modulator (PHAS)
 - Different versions for wavelength ranges between 250 and 1100 nm
 - With 4 crystals in order of compensation
 - Connectors: 4 mm banana plugs
 - Extinction: > 250:1 (VIS, IR) or > 100:1 (UV) (measured at continuous wave between crossed polarizers)
 - Wavefront distortion: < $\lambda/4$ at 633 nm
 - Bandwidth (3 dB): 100 MHz
 - Capacitance: 82 pF
- Modulator series LM 0202 are also available with ADP crystals for an even more precise performance

Highlight



A closer look

ADP has less and weaker piezo ringing and stronger temperature change of switching voltage compared to KD*P

23

Laser Modulators LM 13

The LM 0202 or LM 13 Series Electro Optical Modulators are typically used when intensity, power, phase or polarization state modulation is required. The devices are ideal for continuous- or pulsed-laser applications. The modulators are typically used with diode lasers, solid-state lasers, ion lasers, gas lasers or white-light lasers.

Applications

- Laser scanning microscopes
- Stereo lithography
- Laser projection
- Optical storage
- Printing
- Research and development
- Communication engineering

- Different versions: Universal Modulator, Intensity Modulator (P) with thin film polarizer, Phase Modulator (PHAS)
- With two crystals in order of compensation
- Connectors: 4 mm banana plugs
- Different versions for wavelength ranges between 250 and 1100 nm
- Extinction: > 250:1 (VIS, IR) or > 100:1 (UV) (measured at continuous wave between crossed polarizers)
- Wavefront distortion: < $\lambda/4$ at 633 nm
- Bandwidth (3 dB): 100 MHz
- Capacitance: 46 pF

Highlight



Digital Pulse Amplifier DIV 20

The digital pulse Amplifier DIV 20 is a fast and high-performance, high-voltage driver for all LM0202 and LM13 Laser Modulators with half wave voltage up to 590 V.

Generates rectangular voltage pulses of variable pulse length and adjustable amplitude.

Control via 5 V TTL signal.

Product	Part No.
Digital Puls Amplifier DIV 20	845020620000

Highlight



MECHANICS High-Precision Components for Your Optics

Over the decades, you have come to expect a consistently high level of quality from us in the manufacture of optomechanics – and rightly so. All mechanical components from Qioptiq feature superlative German engineering and of course are perfectly adapted to our optical components. Our policy: Everything from a single source! You know that high-quality optics require high-precision mechanics, whether for mounting, positioning or for 3D structures.

The Qioptiq product line includes the LINOS Microbench® and Nanobench® systems, as well as Tube Mounting System C. We also have a wide array of positioners, rail systems in a broad range of dimensions, and numerous structural components that are indispensable for your laboratory.

24

LINOS Microbench: The Original

A multitude of mechanical components for spatial structures, with compact dimensions, perfectly centered and extremely stable. Combined with our optics, from lenses to achromats to mirrors all specially designed for our Microbench, you get an unbeatable team.

Microbench is a compact component system for numerous areas of application – from lighting and imaging structures to optical experimental setups, measurement / inspection equipment and interferometric applications, to name just a few.

The basic principle lies in the combination of standardized mounting plates for integrating optics of all types, connected by stainless steel rods. Both linear and spatial setups can be implemented quickly and easily.

Quality criteria

- German manufacturing expertise
- High-quality, extremely durable materials
- Surface finishing with precision anodizing
- Narrow production tolerances
- Our guarantee: Complete compatibility of all Microbench series components - from 1968 to today

LINOS Microbench: Basic Set

The case contains all components of the following sets:

- Microbench Set Mechanics G060004000
- Microbench Set Optics G062004000

Types of systems that may be assembled:

- Microscopes
- Off-axis viewers
- Telescopic systems
- Measuring telescopes
- Collimators
- Polarizers
- Projection systems
- Graticule projectors
- Beamsteering systems
- Beamsplitter systems
- Interferometers
- Illumination systems



Basic Microbench components



Product	Part No.
Microbench Set Optics and Mechanics	G062055000

LINOS Tube Mounting System C

Highlight

The Tube Mounting System C is a modular component construction system for fast and trouble-free set-up of laboratory instruments, prototypes and small-batch production. Tubes are available in diameters of 30 mm and 35 mm. Threaded sockets and threaded rings enable the connection of a wide range of optics, with diameters from 6 mm to 31.5 mm.

With the Tube Mounting System C, creating your own lens and expander systems is a breeze. Adapter rings make this system compatible with the connecting threads on C-Mounts, microscopes and CCD cameras. Fine adjusters and focusing mounts let you make small changes in the length for highly precise focusing. Tube Mounting System C and Microbench are excellent in combination; for example, to create a light-tight and dust-tight beam path.

The Tube Mounting System C is compatible to the Microbench and is being constantly extended with new components.

- Modular component system
- Compatible to our Microbench system
- For unmounted optics with \varnothing 6 mm to 31.5 mm
- Compatible with C-Mount, microscope and CCD cameras threads

Applications

- Laboratory instruments
- Samples
- Prototypes
- Small-batch productions
- Lenses and expander systems



Basic Tube System C components



Combination of Tube Mounting System C and Microbench

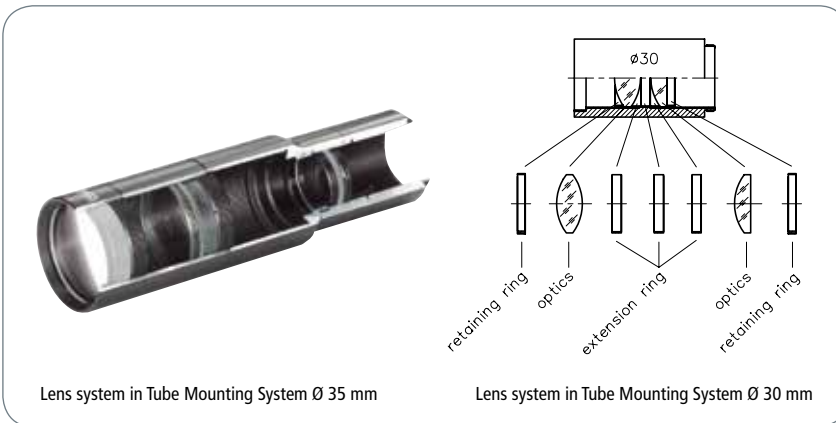

Lens system in Tube Mounting System Ø 35 mm

Lens system in Tube Mounting System Ø 30 mm

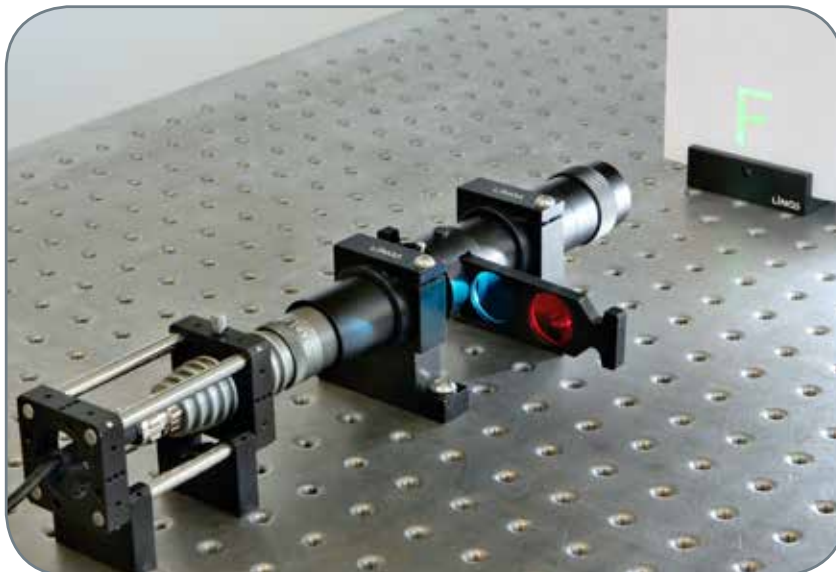

A LED lamp with C-Mount thread is shining inside the tube with an integrated variable filter support. The object inside the tube is projected on a screen by exploiting a lens.



Optics adjustment along the Z axis

Tube Mounting System C - Mechanics Set

- Includes all most important mechanic parts for an easy start with the Tube Mounting System C



Product	Part No.
Tube Mounting System C - Mechanics Set	G064071000

New

SPCM Connector Kits

For a quick and comfortable installation of Excelitas Single Photon Counting Modules (SPCMs), we offer two optomechanical connector kits. Both kits are suitable for the freespace bracket versions of the SPCMs and allow an easy and stable alignment of the focus on the detector area.

- Compatible with LINOS Microbench and LINOS Tube System C
- Wavelength region: 450-700 nm
- Adjustment of achromat for moving focal spot in z-direction
- Adjustment of mirror for moving focal spot in x-y-plane
- Set of parts for individual assembly

Product	Part No.
SPCM Connector Kit TC	G060412000
SPCM Connector Kit MB	G060413000

SPCM Connector Kit TC

- Tube System with C-mount (1.00"-32) threading (LINOS Tube System C)
- Using freespace SPCM with fiber-coupled light
- Suitable for bracket type 2
- FC/PC or FC/APC connector for single-mode optical fiber
- Complete isolation of scattered light



Application example of the SPCM Connector Kit TC (Fiber and SPCM with bracket not included)

Content of the SPCM Connector Kit TC

Qty.	Part No.	Description
1	G061667000	Adapter ring , C-mount - M23.2x0.75
1	G065225000	Adjusting tube C30 with locking collar
1	G065235000	Beam deflector cube C40
1	G063730000	Adjustable mirror Insert 30
1	G000699223	Cover cap with 30 mm diameter
1	G340523000	Plane mirror RAGV; D=22.4x31.5 d=3.5
1	G169013000	Focusing collimators MB 02 (with APC fiber adapter)
1	G038853000	FC fiber adapter (alternatively usable)

- For individual modifications all parts can be ordered separately

26

SPCM Connector Kit MB

- Extremely stable 30 mm optical cage system (LINOS Microbench)
- For focusing collimated light beams on the detector area of freespace SPCM
- Suitable for both bracket types



Application example of the SPCM Connector Kit MB (SPCM with bracket not included)

Content of the SPCM Connector Kit MB

Qty.	Part No.	Description
4	G061209000	Rod 75 mm
1	G061063000	Z-fine adjustment M
1	G063127000	Achromat VIS ARB2; D=18; F=40
1	G061081000	Cube 30
1	G063730000	Adjustable mirror insert 30
1	G340523000	Plane mirror RAGV; D=22.4x31.5 d=3.5
1	G061011000	Set of threaded pins M2.3x3, 150 ea.

- For individual modifications all parts can be ordered separately

fle.X-Plate

NEW Design

The fle.X-plate is a monolithic adjustment unit with flexures, ideally suited for centering fibers, fiber-optics and spatial filters like pinholes, down to μm -accuracy and even sub- μm level. It is available in 3 different versions.

Product	Part No.
fle.X-Plate XY Al	G067032000
fle.X-Plate XY Steel	G067021000
fle.X-Plate XY Diff	G067033000



fle.X-plate XY Al



fle.X-plate XY Steel



fle.X-plate XY Diff

Main features, common to all versions

- 0.5 mm full adjustment range for X and Y direction
- Central mounting bore with 12.5 mm in diameter
- Monolithic design, no moving parts
- Displacements based on short and special shaped flexures. No play, friction or hysteresis
- X and Y translations are coplanar. No unwanted movements causing tilts
- Fully centrosymmetric design with the "thermal center of gravity" at the mounting bore
- Pure X & Y translations without any parasitic effects like tilts
- Four M2.3 screws for fixing in the LINOS Microbench are included in delivery



Application example of our fle.X-plates:

Along with the FSMA fiber optic adapter the fle.X-plate holds the core of the fiber exactly in the focal spot of the focusing lens. The fle.X-plate allows a fine adjustment as well as a long term and temperature stability that is ideal for fiber coupling.

You can buy this complete component set (fiber not included): Q-Set Fiber Coupler, Part-No. G060408000

fle.X-plate XY Steel and fle.X-plate XY Al

- Each translation is controlled by two screws, a pulling screw and a pushing screw
- Final super-fine adjustment is realized by controlling the final torque level of both screws, which action automatically secures the locking of the final setting at the same moment
- Extremely good long-term stability over a wide temperature range due to the monolithic and centrosymmetric design, the "thermal center of gravity" and the locking mechanism
- fle.X-plate XY Steel is made from hardened steel and ideal for permanent setups and production equipment. It offers highest precision, sensitivity and stability better than 1 μm
- fle.X-plate XY Al is made from anodized aluminum. Its sensitivity and stability is at μm level
- Both plates are delivered with tools for the adjustment screws

fle.X-plate XY Diff

- XY-adjustment is achieved using two differential screws, while two strong springs eliminate the residual play of the differential screws
- The pitch is 0.1 mm per rotation
- Ideal for experimental setups and ease of use in the lab and for regular and quick adjustments

Up to the sky

fle.X-plates with a slightly modified design were selected by the German Aerospace Center (DLR) for holding the detectors of the Laser Ranging Interferometer that is located in the GRACE-FO satellites. The GRACE-FO mission is a community project between the National Aeronautics and Space Administration (NASA) and the German Research Center for Geosciences (GFZ).

By measuring the varying distance between this twin satellites components of the earth's gravity field can be obtained which leads, inter alia, to a better observation of the melting of the polar caps.

For such particularly high requirements these fle.X-plates were made out of titanium but the pattern of the flexure was based upon the fle.X-plate itself.

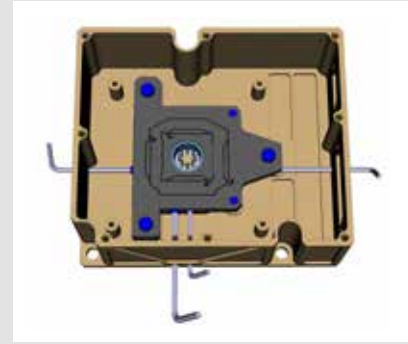

CAD construction of modified titanium fle.X-Plate in a case housing a detector in its central hole.

Adjustment guide for XY Steel/Al

- X and Y direction, each have two adjustment screws, one pulling screw and a smaller one pushing via a steel ball.
- Coarse to fine adjustment is done by adjusting both screws simultaneously at a rather low torque level, in order to arrive easily near the intended position within several μm 's.
- Subsequently this X or Y position is then gradually blocked by enlarging the torque levels of both screws to a much higher fixation level. By tuning the torque level of one screw or of both screws the position is being blocked for the long term but, simultaneously, can also being tuned down to sub- μm finesse by means of the torque ratio between the two screws.
- Hertz' deformation by tuning the preload on a steel ball, rather than usual displacement from a spindle, is the basis of combining sub- μm tuning with automatic blocking
- Usually securing of the final position is done subsequently with lock nuts, but this always influences the adjusted position. This problem is avoided by the automatic blocking mechanism of the fle.X plate.

Linear Stages Compatible To Our Microbench System

Technical Introduction

The following section explains the most important technical terms in precision positioning technology in order to make it easier for you to select the optimum positioning system for your needs.

Accuracy

The accuracy of a linear positioning system can be divided into two categories:

1. The accuracy of the path itself, referred to in technical terms as guide accuracy.
2. The linear positioning accuracy along the path.

The former is a property of the guide system (guide, ball-bearings, crossed-roller bearings, etc.) and characterizes the degree of accuracy with which motion takes place in a defined direction. The latter refers to the conversion of drive into linear motion. The limiting influences are lead-screw properties or other feedback mechanics.

Guide accuracy

Every object has six degrees of freedom (see Fig. 1). These are the linear motions along the three orthogonal axes X, Y and Z as well as the rotations around these axes (θ_x , θ_y and θ_z). The task of a linear guide is to restrict the motion of an object precisely to one of these axes (typically referred to as X-axis). Any deviations from rectilinear motion along the X-axis are the consequences of inaccuracy in the guide system.

Five possible guide errors remain: motion in the X-direction, motion in the Z-direction, rotation around the X-axis (roll), rotation around the Y-axis (pitch) and rotation around the Z-axis (yaw) (see Fig. 2).

With linear positioning elements, the mainly linear motion arises from the interaction of a large number of points of support along the length of the guide. That is why any deviation of the individual guide from a straight line results both in a translational error and an angle error. As the average straightness error in the individual guide is generally extremely small, the angular errors

can be neglected for most purposes. On the other hand, even small angular errors do add up over large guide lengths to considerable linearity deviations. The combination of pitch and displacement in the Z-direction yields the flatness and the combination of yaw and displacement in the Y-direction yields the straightness (see Fig. 2).

Positioning Accuracy

Most linear positioning systems use leadscrews to transform the rotation of a motor into linear motion. The quality of the leadscrew determines the accuracy of the positioning system. The leadscrew nut should be free from backlash which will reveal itself upon direction reversal.

Accuracy analysis of the leadscrew error distinguishes between the cumulative error over the path and the periodic error which occurs with leadscrew rotation.

High positioning accuracy is attained using interferometric measurement, compensation data determination and online axis compensation.

28

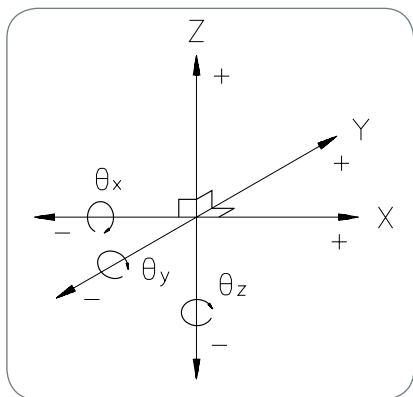

Fig. 1

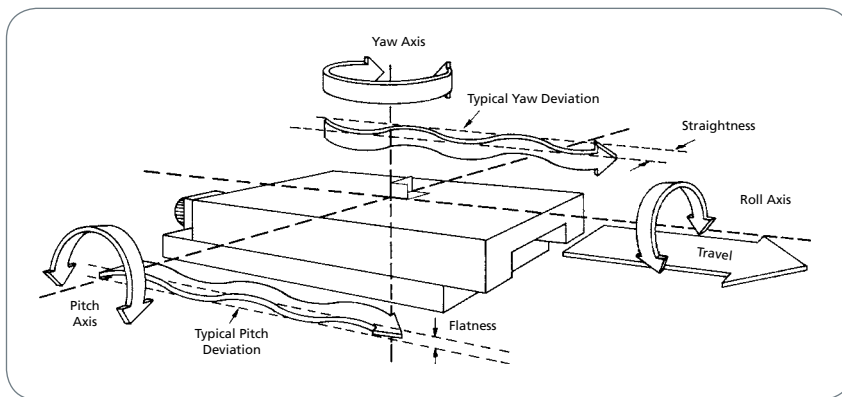

Fig. 2

Linear Stages T10 M/F, TS10 M/F

These linear stages are available in four versions, central or offset drives, with micrometer screw or with fine adjustment screw.

The stages T 10 F and TS 10 F are equipped with a fine-adjustment screw with 0.25 mm pitch.

The spindle has a hexagon socket and can be driven by the provided knurled hexagon knob. If the hexagon socket is not needed, the knob can be glued in.

- High-precision ball bearings
- Accurate movement without any play
- 10 mm travel
- Screw pitch 0.25 mm
- Micrometer resolution 10 μm
- Sensitivity 1 μm (type M)

Product	Part No.
Linear stage T 10 M	G080111000
Linear stage TS 10 M	G080211000
Linear stage T 10 F	G080113000
Linear stage TS 10 F	G080212000

Highlight



T 10 M



T 10 F



TS 10 M



TS 10 F

Microbench compatible

All versions of the Linear Stages T/TS10 are ideally suited for applications in our LINOS Microbench system.



29

Linear Positioners TM/TMS

Compact positioners available in stainless steel and aluminum versions. Backlash-free, pre-stressed crossed-roller bearings for the highest guiding accuracy, even with heavy loads.

These positioners can be used horizontally and vertically. Choose from three table sizes, which can also be combined using adapter plates.

Or make your own XYZ structure with no further accessories at all. Different threaded holes ensure compatibility to our construction systems.

- High load capacity
- Large through hole
- Travel range 5-25 mm
- Crossed-roller bearings
- Micrometer with 0.25 mm pitch (TM 30-05, TM 50-16)
- Micrometer with 0.5 mm pitch (TM 90-25)
- Sensitivity < 1 μm
- Ultra-flat design with heights of 11 to 16 mm

Product	Part No.
Linear stage TM 30-05	G403370000
Linear stage TM 50-16	G403371000
Linear stage TM 90-25	G403372000
Linear stage TMS 30-05	G403380000
Linear stage TMS 50-16	G403381000
Linear stage TMS 90-25	G403382000

Highlight



TM 30-05



TM 50-16



TM 90-25



TMS 90-25



Example for a XYZ Combination without any additional brackets

X95 Profile System

The X95 Profile System includes both profiles and carriers, and is a versatile construction system for optics and precision mechanics. It is particularly well suited as an optical bench, or for table and frame structures.

X95 Profile

An X95 Profile is a hollow, cylindrical aluminum profile with four lateral ridges which reinforce the system and also hold the carriers. These ridges increase the torque of inertia and torsional strain considerably. Four threaded bore holes on the profile end planes provide fastening options for connectors or caps.

The X95 Profiles are available in many standard lengths. Custom lengths of up to 3 m can be supplied on request.

- For assembling tables or framework structures
- Mount on vibration-isolation platforms/ columns
- Hollow extrusions with cruciform arrangement of longitudinal ribs
- Allows assembling of three-dimensional structures
- Smooth-gliding carriers equipped with spring-loaded clamps
- Easy assembling

- Colorless anodized aluminum
- Moments of inertia $J_x / J_{\Delta} \sim 220 \times 10^4 \text{ mm}^4$
- Torsional stress $J_0 \sim 1.2 \text{ kg cm}^2$ per cm length
- Young's modulus $E \sim 70 \text{ kN/mm}^2$
- Tolerance warpage 0.5 mm/m
- Tolerance twist 0.6 mm/m

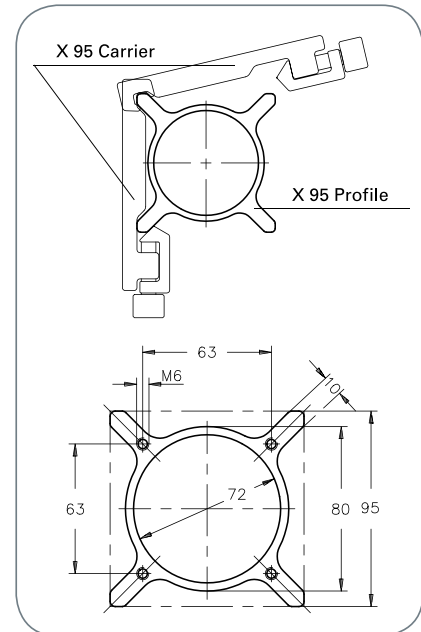

Dimensions X95 Profile

Your benefit

- Lightweight, modular and robust construction system
- Quick and easy setup
- Short lead times guaranteed
- Compatible to our other systems

30



X95 table construction for an assembly of complex optical systems in a clean room at Qioptiq in Göttingen.



The DLR Institute of Aerodynamics and Flow Technology (AS) uses X95 components for mounting cameras and lasers for its research on the aerodynamics of airplane components.

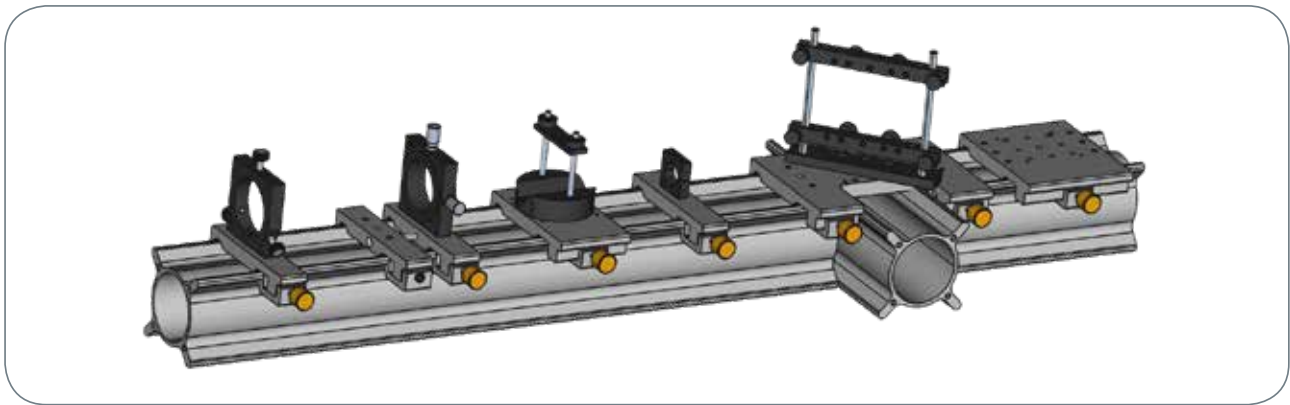

X95 Profile System used as an optical bench

Carriers X95

The Carriers X95 can be utilized to mount components onto an X95 Profile. A Teflon film on the bottom side allows a smooth gliding of the carriers on the X95 Rails and therefore provides a precise adjustment. The thumb screws enable a flexible locking and unlocking of the carrier's position without additional tools. The carriers are available with or without hole pattern either with black or with colorless anodizing.

Selection guide

The Carrier - Microbench gives you the connection to our high performance system. This multifunctional cage system is well known for the highest axial precision in the market.

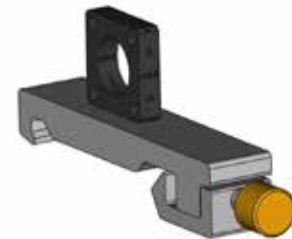

Carrier - Microbench (MB)



Application example: A measuring station for determining geometric parameters of cylindrical lenses built by OEG GmbH out of X95 components.



X95 Profile System components holding an Optem FUSION Lens System

INSTRUMENTS High-Quality Laser and Light Sources

The world's first working laser was invented by U.S. physicist Theodore Maiman in 1960. Today, there are countless applications that simply would not exist without laser technology. We help to make it possible, with a broad spectrum of laser types for wavelengths ranging from 375 nm to 3800 nm, and output levels of up to 800 mW.

We design and manufacture high-performance solid-state laser systems and fiber optics as well as HeNe lasers. For image reproduction with CDD cameras or with viewing devices such as microscopes, we offer halogen and xenon cold light sources — and LED light sources as well. Small lamp houses for halogen lamps, directional and spectral lamps, all compatible with LINOS mounts, posts and holders, are particularly well suited for laboratory setups.

32

iFLEX-iRIS - Compact, Single-Wavelength Laser Series

The iFLEX-iRIS® laser series is a range of solid-state, high-performance lasers with low amplitude noise. For ease of use and integration, all wavelengths are offered in the same compact package with the same control inputs. All TEC and smart control electronics are integrated in the laser. They make ideal building blocks for OEM instrument designers and researchers alike.

Closed Loop Modulation (CLM):

The innovative Closed Loop Modulation (CLM) feature allows the lasers to operate with automatic power control feedback in all modes of operation; CW, plus digital, analogue and dual mode modulation. These lasers maintain excellent power stability in all modes of operation and throughout the laser lifetime. Unlike traditional open loop laser modulation, there is no need for laser calibration reset when using iFLEX-iRIS lasers with CLM feature.

Lasers with CLM are ultra-low noise in terms of RMS, RIN and periodic noise. They also offer precision adjustment at all output power levels. This is very useful for imaging applications where a stable, ultra-low noise source will improve the signal-to-noise ratio and image resolution.

Fiber Delivery:

The iFLEX-iRIS lasers can be supplied with a single-mode fiber output. Alternatively, and as requirements change, the single-mode fiber can be added easily by the user. Thus, the iFLEX-iRIS provides true "Plug and Play" versatility as a free-space or fiber-coupled laser.

iFLEX-iRIS lasers are designed to fiber couple into the kineFLEX fiber delivery system. As a result these lasers are ultra-stable when used as free space or fiber coupled. There are standard options for different fiber lengths and either collimated or connector outputs.

CDRH Compliance for End Users:

iFLEX-iRIS lasers are CDRH compliant when used with an iFLEX-iRIS CDRH interlock power supply.



Applications

- Metrology
- Flow cytometry
- Confocal and laser scanning microscopy
- Dynamic light scattering
- Forensics, DNA screening, Genomics
- High-resolution imaging systems
- Ophthalmology

Wavelengths (nm) and Power (mW)																				
375	405	415	445	458	473	488	505	515	520	532	561	594	633	640	647	660	670	730	780	852
20	50	100	20	20	75	20	50	20	30	20	20	20	30	20	50	80	10	20	70	35
40	100		50	70		40		50		40	40		70	40						
50	200		75			100		60						100						
	220					140								150						

Available wavelengths and output powers of our iFLEX iRIS lasers

iFLEX-Agile Series CW-OPO Optical Parametric Oscillator

Technical Introduction

An OPO consists essentially of a nonlinear optical crystal within an optical resonator. When focusing a pump wave of frequency ω_p into the crystal two new waves, signal and idler, with frequencies ω_s and ω_i are generated via parametric fluorescence following the conservation of energy $\omega_p = \omega_s + \omega_i$. The optical resonator serves to resonate at least one of signal and idler waves. Inside the nonlinear optical crystal, the pump, signal and idler waves overlap. The interaction between these three waves leads to amplitude gain for signal and idler waves (parametric amplification) and a corresponding depletion of the pump wave.

When the pump-power exceeds a threshold where the losses of the resonating wave are compensated, the gain allows the resonating wave to oscillate inside the resonator. As a result of mode competition one discrete pair of signal and idler frequencies can be selected, the pair experiencing the highest gain (where the phase-matching of the three interacting waves are best).

A frequency tuning of the two generated waves can be done by changing the phase-matching condition (mainly given by crystal and also resonator properties).

Very common in this context is the use of periodically poled crystals (a specially structured crystal for quasi-phase-matching).

The OPO process is a very efficient means for frequency conversion of a laser wave.

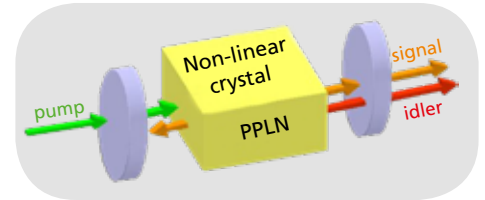

Scheme of an OPO with pump, signal and idler beams

The New iFLEX-Agile® Series is a high-power, continuous-wave OPO featuring exceptionally broad wavelength tunability.

Ideal for a variety of applications in mass spectrometry, material testing, spectroscopy, and metrology, this new compact instrument allows fine-tuning of specific wavelengths from NIR to MIR, for high-quality output beams of high intensity. Fully controlled via USB computer interface, iFLEX-Agile enables rapid and reproducible settings of any desired wavelength from 1.48 – 2.0 μm and 2.3 – 3.8 μm with output powers >1W in its basic configuration, and without any need to change optics or modules. iFLEX-Agile emission linewidths can vary from 500 GHz to below 1 MHz depending on the configuration.

The modular concept allows modification of wavelength tuning range, emission linewidths and output power levels to cost-efficiently meet the custom requirements for specific applications including trace-gas analysis, material inspection, chemical reactions and IR-detector calibration. The iFLEX-Agile can also be customized for extended wavelength range (e.g. additional 740-950nm), narrow linewidth at 2300-3800nm, higher power levels, higher wavelength tuning resolution, and mode-hop free tuning ranges.

Applications

- Trace-gas analysis
 - Spectroscopy
 - Metrology
 - Detector calibration
 - Mass spectrometry
 - Material (specification) tests
- Broad wavelength tunability at high-power continuous-wave outputs >1W
 - Rapid tunability via USB interface across 1480-2000nm and 2300-3800nm from a single OPO-module without exchange of optics



Customized adaptation, e.g.

- Narrow linewidths <1 MHz over the whole emission range
- Higher power levels
- Broader wavelength emission range, e.g. additional 740-950nm

iFLEX-Agile Series CW-OPO		
Wavelength tuning range (linewidth)	(nm)	1480-2000 (<1 MHz), 2300-3800 (appr. 300-500 GHz)
Output power	(W)	> 1.0 (depends on wavelength, excluded OH-absorption around 2.8 μm)
	(W)	> 0.3 for low-power version
Beam Quality	M^2	< 1.3
Cooling		Air
Dimensions table-top OPO head module	(LxWxH)	45x15x20 cm^3
Dimensions pump laser		19" rackmount 3U
Wavelength setting		via USB interface

Your benefit

- Broad wavelength tunability
- Rapid modulation from one single OPO module
- No optics changes necessary
- Exceptional emission beam quality
- Custom options regarding pump sources, output powers and linewidths

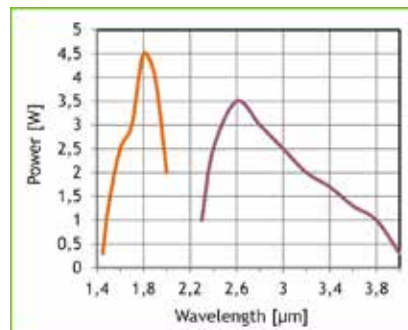

Example: Output power versus the wavelength of the two emitted laser beams

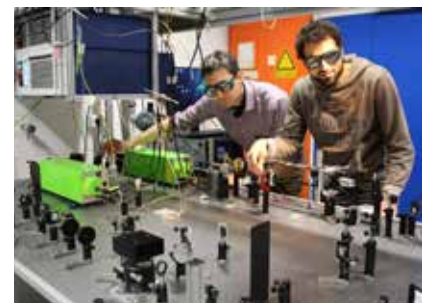

At university of Kassel narrow linewidths versions of iFLEX-Agile are applied in astrophysics. See also: Laser Focus World, Dec 2018, page 35.

REO Helium-Neon Lasers

Excelitas' REO brand legacy is derived from HeNe Laser manufacturing: Superior HeNe Lasers require the highest quality laser optics. Today, Excelitas is the world leader in high performance HeNe laser manufacturing, which is enabled by our unique combination of optics fabrication and expert assembly capabilities.

REO is the only HeNe laser manufacturer that integrates our proprietary in-house designed and manufactured laser mirrors. REO has for years provided the clear majority of laser mirrors to other well-known HeNe manufacturers.

We were the first company to successfully develop mirrors for volume green HeNe lasers, with their notoriously low gain. Application of our design and optics manufacturing experience developed a unique frequency and intensity stabilized HeNe laser product. This provides an ideal solution for instrumentation and metrology applications which require long coherence length and high amplitude stability.

- Standard HeNe-Lasers in stock
- From visible to mid-infrared wavelength region
- Stabilized, high-power and multi-line versions available
- Unique metallic laser-body design allows for robust handling and mounting options
- Patented stabilized HeNe: higher power than competing designs
- Patented green HeNe laser (543 nm): lower loss than traditional Brewster window

Applications

- FTIR (Fourier-transform infrared spectroscopy) applications
- Confocal microscopy
- Ellipsometry
- Particle counting
- Metrology
- DNA sequencing
- Alignment
- Imaging and medical equipment
- Opacity monitoring
- Hematology
- Semiconductor inspection
- Polarization experiments and more



New



Selection of Laser Heads from the HeNe 633nm Series

Wavelength (nm)	Power (mW)	Polarization	Part No. REO System	Part No. Laser Head	Part No. Power Supply
Stabilized HeNe Laser System, Red 633 nm					
633	1.5	Polarized	32734	32732	32733
HeNe Laser Systems, Red 633 nm					
633	0.5	Random	31008	39898	39783
633	0.8	Polarized	31007	30404	39783
633	1.5	Random	31005	30404	39783
633	1.5	Polarized	30025	30028	39783
633	2.0	Random	30988	30629	39783
633	2.0	Polarized	30989	30621	39783
633	3.0	Orthogonal	14354	N/A	39783
633	5.0	Random	30990	30630	39783
633	5.0	Polarized	30991	30623	39783
633	12.0	Random	30992	30633	39785
633	12.0	Polarized	30993	30624	39785
633	17.0	Random	39635	30635	39786
633	17.0	Polarized	30995	30625	39786
633	30.0	Polarized	16194	Integrated	Integrated

Detailed information regarding REO HeNe Lasers: www.reohenelasers.com.



Example of a HeNe Reo System consisting of a stabilized Laser Head and a Power Supply



Tunable Line HeNe Reo System with integrated Power Supply

Wavelength (nm)	Power (mW)	Polarization	Part No. REO System	Part No. Laser Head	Part No. Power Supply
Green HeNe Laser Systems, 543 nm					
543 (multimode)	0.5	Polarized	40141	30683	39783
543	0.5	Random	30967	30605	39783
543	0.5	Polarized	30968	39682	39783
543	1.0	Polarized	39581	30526	39784
543	1.5	Polarized	33361	32565	39784
543	2.0	Random	30927	30609	39784
Yellow HeNe Laser Systems, 594 nm					
594	1.0	Polarized	40094	30571	39783
594	2.0	Polarized	39582	30639	39783
Infraed HeNe Laser Systems					
1152	1.0	Polarized	40136	30684	39785
1523	1.0	Polarized	33141	30612	39785
3390	2.0	Polarized	32172	30685	39785
Dual Line HeNe Laser Systems					
1523/633	1.8	Polarized	40137	30583	39785
1152/3390	5.0	Polarized	40138	30615	39785
Tunable Line HeNe Laser Systems					
633	4.0	Polarized	30602	Integrated 115 V	
612	2.5				
604	0.5		30603	Integrated 230 V	
594	0.6				
543	0.3				

Detailed information regarding REO HeNe Lasers: www.reohenelasers.com.

Europe
+49 (0) 551 6935-0

North America
+1 (800) 429 0257

Asia/Pacific
+65 64 99 7777

www.excelitas.com

© 2019 Qioptiq Photonics GmbH & Co. KG. All rights reserved. Qioptiq reserves the right to change this document and the technical data contained herein at anytime without notice and disclaims liability for editorial, pictorial and typographical inaccuracies.

O-CA-BR-News-Highlights_EN_2019-06 | 2424-301-001-02