

CLIFF

DUALSLIM USB3.0 A-A METAL FRAME FEEDTHROUGH CONNECTOR

Can be front or rear mounted in the panel

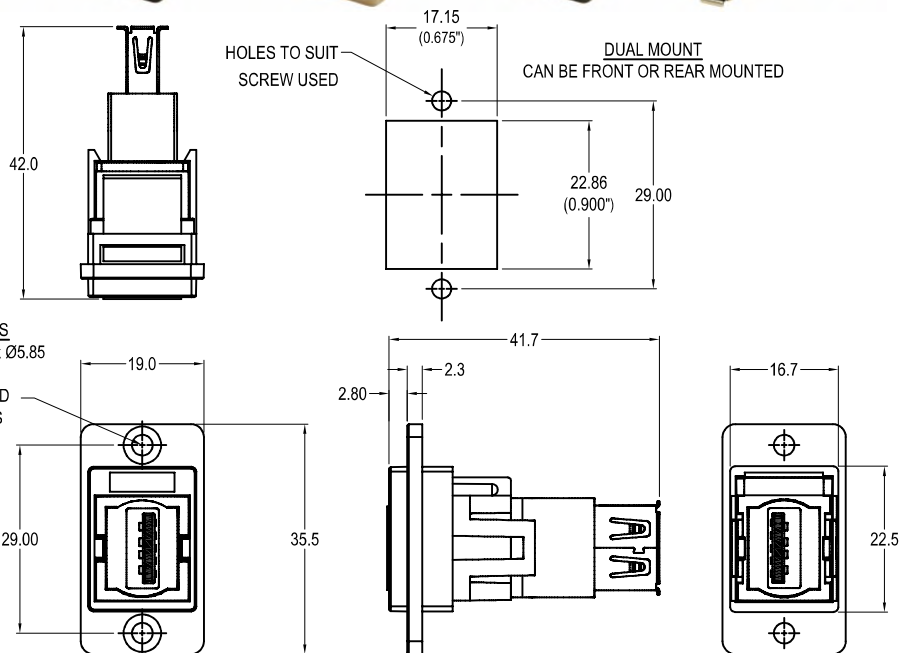

VARIANTS

Part No.

CP30705NM	DUALSLIM USB3.0 A-A Nickel frame, CSK holes
CP30705NMB	DUALSLIM USB3.0 A-A Black metal frame, CSK holes
CP30705NM3	DUALSLIM USB3.0 A-A Nickel frame, M3 holes
CP30705NMB3	DUALSLIM USB3.0 A-A Black metal frame, M3 holes
CP30705NM440	DUALSLIM USB3.0 A-A Nickel frame, #4-40 holes
CP30705NMB440	DUALSLIM USB3.0 A-A Black metal frame, #4-40 holes
CP30705NMX1	DUALSLIM USB3.0 A-A Nickel frame, Ø3.2 PLAIN holes
CP30705NMBX1	DUALSLIM USB3.0 A-A Black metal frame, Ø3.2 PLAIN holes

Feedthrough Features

- Fits standard rectangular cutout.
- Front or rear mounting through the panel.
- Various hole mounting options.
- No soldering or punch termination. Use standard cable for each connector style.
- Low rear profile.

General:

Please note: Functionality is affected by cable quality, length and cable wiring configuration.

Material:

1. Insert: ABS UL94 HB
2. Frame: Diecast, Nickel or Black plated
3. Inner Overmouldings: PE + PVC
4. Shell: Nickel plated steel
5. Contacts: Gold Plated

Notes:

1. Voltage rating: 30V ac
2. Current rating: 1.8 A max
3. Contact resistance: 50mΩ max
4. Insulation resistance: 20MΩ min
5. Dielectric withstanding voltage: 500V AC
6. Operating Temperature: -20°C to 50°C