



15DRW4_2.25 series

15W - Single Output - Wide Input - Isolated & Regulated DC-DC Converter

DC-DC Converter 15 Watt

- ⊕ Wide 4:1 input voltage range
- ⊕ Isolation Voltage: 2.25kVDC
- ⊕ Operating Temperature Range: -40°C to +85°C
- ⊕ Short circuit protection (SCP)
- ⊕ International standard pin-out
- ⊕ EN50155/EN60950/UL62368/IEC62368 approved
- ⊕ High efficiency up to 85%
- ⊕ Low ripple & noise
- ⊕ EMI meet EN55032 CLASS A, without external components
- ⊕ RoHS Compliance
- ⊕ Over voltage protection
- ⊕ Over load protection
- ⊕ Input under voltage protection
- ⊕ Meets requirements of railway standard EN50155

The 15DRW4_2.25 series are isolated 15W DC-DC products with 4:1 input voltage. They feature efficiency up to 86%, 2250VDC isolation with enhanced isolation, operating temperature of -40°C to +85°C, input under-voltage protection, output short circuit, over-current and over-voltage protection. Railway vehicle electronic equipment widely used in 72V, 96V and 110V. The modules are fully featured, protected and include remote On/Off and Trim function for output voltage adjustment.



UL-62368-1 (E347551)

Common specifications

Short circuit protection:	Continuous, automatic recovery
Cooling:	Free air convection
Operation temperature range:	-40°C~+85°C
Storage temperature range:	-55°C~+125°C
Maximum case temperature:	105°C
Soldering temperature:	300°C MAX, 1.5mm from case for 10sec
Switching frequency:	300kHz TYP, PWM mode
Storage humidity range:	95% MAX
Shock and vibration test:	IEC 61373, car body 1 B mold
Case material:	Aluminum alloy
Potting material:	Epoxy (UL94V-0)
MTBF (MIL-HDBK-217F @25°C):	>1,000 Khours
Dimensions:	50.80*25.40*11.80mm 50.80*25.40*16.30mm (heatsink)
Weight:	26g/34g (heatsink)

Input specifications

Item	Test condition	Min	Typ	Max	Units
Input current (full load / no load)	• 3.3V output		147/10	150/20	mA
	• 5V output		163/10	167/20	mA
	• Others		159/3	166/8	mA
Reflected ripple current	Nominal Vin and full load			25	mA
Surge voltage	1sec. max.	-0.7		180	VDC
Starting voltage	100% load			40	VDC
Shutdown voltage		28	33		VDC
Starting time	Nominal Vin and constant resistive load		10		ms
Input filter	Pi Type				
Hot plug	Unavailable				
Ctrl (the voltage of Ctrl pin is relative to input pin GND)	• Module switch ON		Ctrl suspended or connected to TTL high level (3.5-12VDC)		
	• Module switch OFF		Ctrl pin connected to GND or low level (0-1.2VDC)		
	• Input current when switched OFF		2	7	mA

Output specifications

Item	Test condition	Min	Typ	Max	Units
Voltage accuracy	0%-100% load		±1	±3	%
Line regulation	Full load, low to high		±0.2	±0.5	%
Load regulation	0%-100% load		±0.5	±1	%
Transient recovery time	25% load step change		300	500	µs
Transient response deviation	normal Vin, 25% load step change • 3.3V/5V output • Others		±3	±8	%
			±3	±5	%
			±0.02	±0.03	%/°C
Temperature coefficient					%/°C
Ripple and noise*	20MHz Bandwidth		50	100	mVp-p
Trim			90	110	%Vo
Over voltage protection	Input voltage range		110	160	%Vo
Over current protection	Input voltage range		120	210	%Io

* 0%-5% load ripple & noise is no more than 5%Vo. Ripple & noise are measured by "parallel cable" method, please see DC-DC converter application notes for specific operation.

Isolation specifications

Item	Test condition	Min	Typ	Max	Units
Isolation voltage*	• Input-output	2250			VDC
	• Input and output respectively on the shell	1600			VDC
Isolation resistance	Input-output, test at 500VDC	1000			MΩ
Isolation capacitance	Input-output, 100KHz/0.1V		2200		pF

* Test time of 1 minute and the leak current lower than 1mA.

Example:

15DRW4_11005S2.25

15 = 15Watt; D = DIP; R = series; W4 = wide input (4:1) 40-160Vin; 110 = 110Vin; 05 = 5Vout; S = single output; 2.25 = 2250VDC isolation

Note:

- Only typical model listed. Non-standard models will be different from the above, please contact us for more details.
- All specifications are typical at nominal input, full load and 25°C unless otherwise stated.
- In this datasheet, all the test methods of indications are based on corporate standards.

15DRW4_2.25 series

15W - Single Output - Wide Input - Isolated & Regulated
DC-DC Converter

EMC specifications					
EMI	CE	CISPR22/ EN55022	CLASS A (see EMC recommended circuit, fig. 2) CLASS B (see EMC recommended circuit, fig. 4)		
EMI	RE	CISPR22/ EN55022	CLASS A (without external components) CLASS B (see EMC recommended circuit, fig. 4)		
EMS	ESD	IEC/EN61000-4-2	Contact ±6KV/Air ±8KV		perf. Criteria B
EMI	RS	IEC/EN61000-4-3	10V/m		perf. Criteria A
EMI*	EFT	IEC/EN61000-4-4	±4KV (EMC recommended circuit, fig. 3 or fig. 4)		perf. Criteria B
EMS	Surge	IEC/EN61000-4-5	line to line ±2KV (2Ω 0.5uF see EMC recommended circuit, fig. 3) line to ground ±4KV (12Ω 0.5uF see EMC recommended circuit, fig. 3)		perf. Criteria B
EMS	Surge	EN50121-3-2	line to line ±1KV (42Ω 0.5uF see EMC recommended circuit, fig. 4) line to ground ±2KV (42Ω 0.5uF see EMC recommended circuit, fig. 4)		perf. Criteria B
EMI	CS	IEC/EN61000-4-6	10 Vr.m.s		perf. Criteria A

Part Number	Input Voltage [VDC]		Output Voltage [VDC]	Output Current [mA] Full load	Efficiency [%, typ.]	Capacitor load [μF, max.]
	Nominal	Range				
15DRW4_11003S2.25	110	40-160	3.3	4000	82	5400
15DRW4_11005S2.25	110	40-160	5	3000	84	5400
15DRW4_11012S2.25	110	40-160	12	1250	84	1000
15DRW4_11015S2.25	110	40-160	15	1000	85	820
15DRW4_11024S2.25	110	40-160	24	625	85	270

Typical characteristics

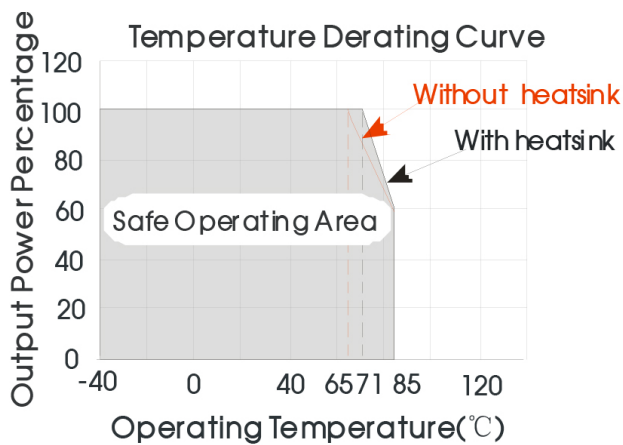

15DRW4_2.25 series

15W - Single Output - Wide Input - Isolated & Regulated DC-DC Converter

Efficiency

Efficiency Vs Input Voltage (Full Load)

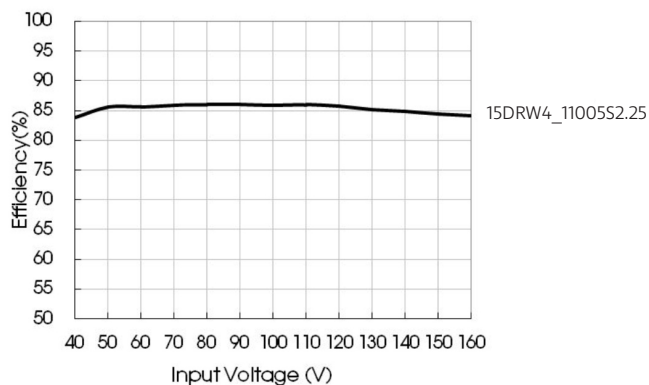

Efficiency Vs Output Load (Vin=110V)

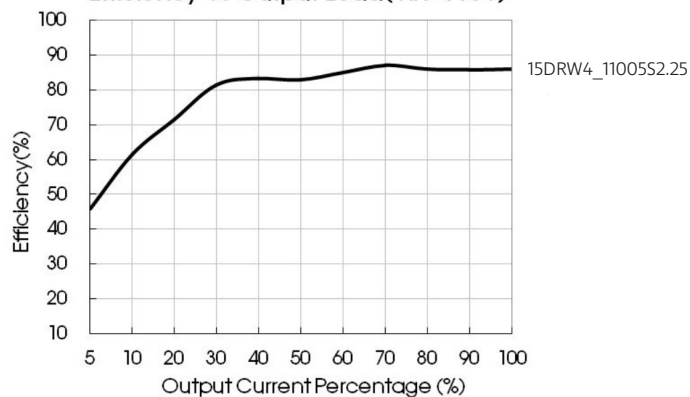

Efficiency Vs Input Voltage (Full Load)

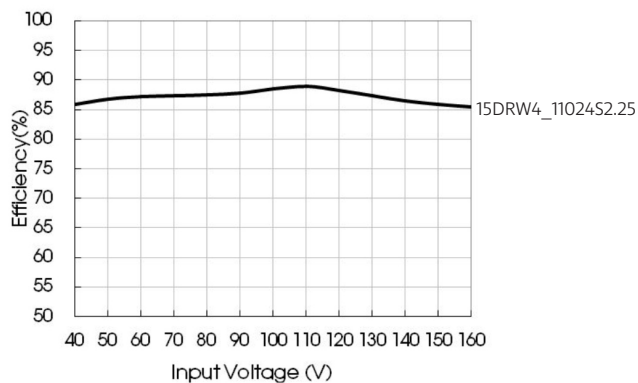

Efficiency Vs Output Load (Vin=110V)

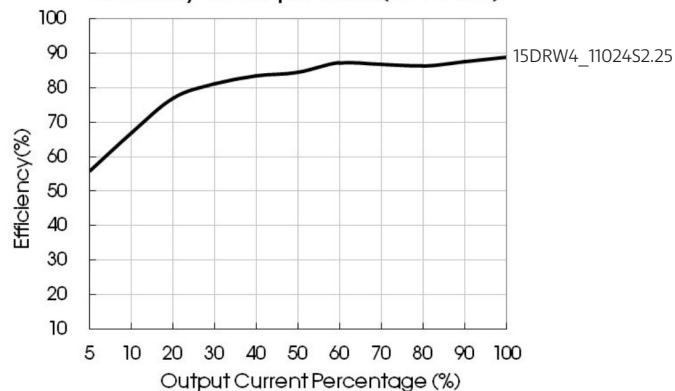

Typical application

All the DC/DC converters of this series are tested according to the recommended circuit (see Fig. 1) before delivery.

If it is required to further reduce input and output ripple, properly increase the input & output of additional capacitors C_{in} and C_{out} or select capacitors of low equivalent impedance provided that the capacitance is no larger than the max. capacitive load of the product.



figure 1

Vout (VDC)	Fuse	Cin	Cout
3.3/5	2A slow blow	10 μ F - 47 μ F	470 μ F
12/15	2A slow blow	10 μ F - 47 μ F	220 μ F
24	2A slow blow	10 μ F - 47 μ F	100 μ F

15DRW4_2.25 series

15W - Single Output - Wide Input - Isolated & Regulated
DC-DC Converter

EMC solution recommended circuit



Note: Fig. 1 Cin please use the 250V withstand voltage of the capacitor. figure 2

Figure 2 parameter description:

Cin	27 μ F -100 μ F/250V
Cout	Refer to the Cout in fig. 1

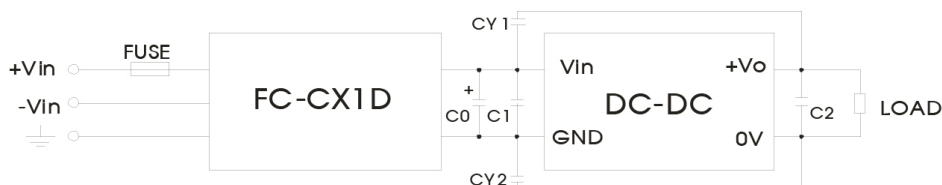
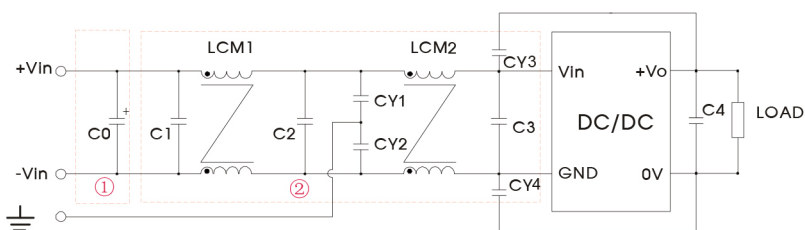

Figure 3 parameter description:

FUSE	Choose according to actual input current
FC-CX1D	FC-CX1D is the EMC auxiliary component of our company. Input voltage range: 40V-160V
C0	100 μ F/200V
C1	Refer to the Cin in Fig. 1
C2	Refer to the Cout in Fig. 1
CY1, CY2	1000pF/400VAC

figure 3



Note: Part ① in the Fig. 4 is used for EMS test and part ② for EMI filtering; selected based on needs.

figure 4

Figure 4 parameter description:

C0	100 μ F/200V
C1, C2	0.22 μ F/250V
C3	Refer to the Cin in Fig. 1
LCM1	15mH (UU common mode inductance)
LCM2	15mH (UU common mode inductance)
CY1, CY2, CY3, CY4	1000pF/400VAC
C4	Refer to the Cout in Fig. 1

It is not allowed to connect modules output in parallel to enlarge the power.

15DRW4_2.25 series

15W - Single Output - Wide Input - Isolated & Regulated DC-DC Converter

Trim application & trim resistance

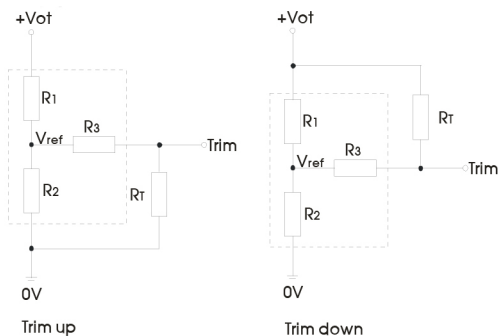

Calculation formula of Trim resistance:

$$\text{up: } R_T = \frac{\alpha R_2}{R_2 - \alpha} - R_3 \quad \alpha = \frac{V_{ref}}{V_o' - V_{ref}} \cdot R_1$$

$$\text{down: } R_T = \frac{\alpha R_1}{R_1 - \alpha} - R_3 \quad \alpha = \frac{V_o' - V_{ref}}{V_{ref}} \cdot R_2$$

Application circuit for TRIM (Part in broken line is the interior of models)
 Note: Leave open if not used. RT: Resistance of Trim. a: User-defined parameter, no actual meanings.

Vout(V)	R1(KΩ)	R2(KΩ)	R3(KΩ)	Vref(V)
3.3	4.801	2.87	10	1.24
5	2.883	2.87	10	2.5
12	11.000	2.87	15	2.5
15	14.384	2.87	15	2.5
24	24.872	2.87	17.8	2.5

Mechanical dimensions

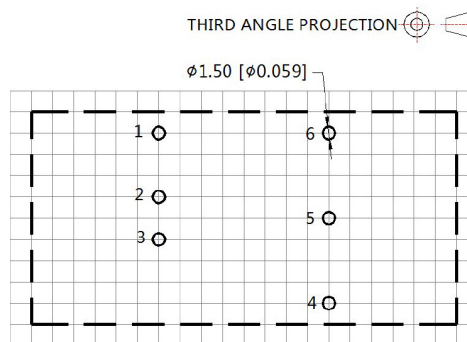
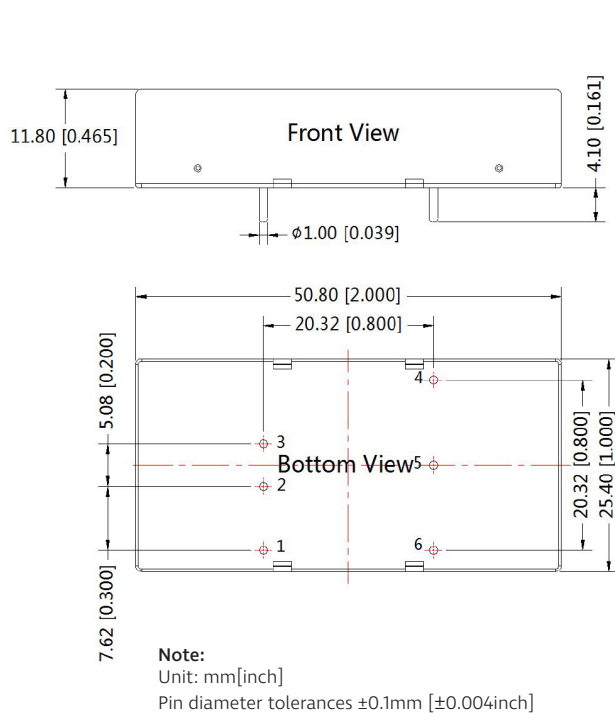

Note : Grid 2.54*2.54mm

Pin-Out	
Pin	Function
1	Ctrl
2	GND
3	Vin
4	+Vo
5	Trim
6	0V

15DRW4_2.25 series

15W - Single Output - Wide Input - Isolated & Regulated
DC-DC Converter

Mechanical dimensions (with heatsink)

THIRD ANGLE PROJECTION 

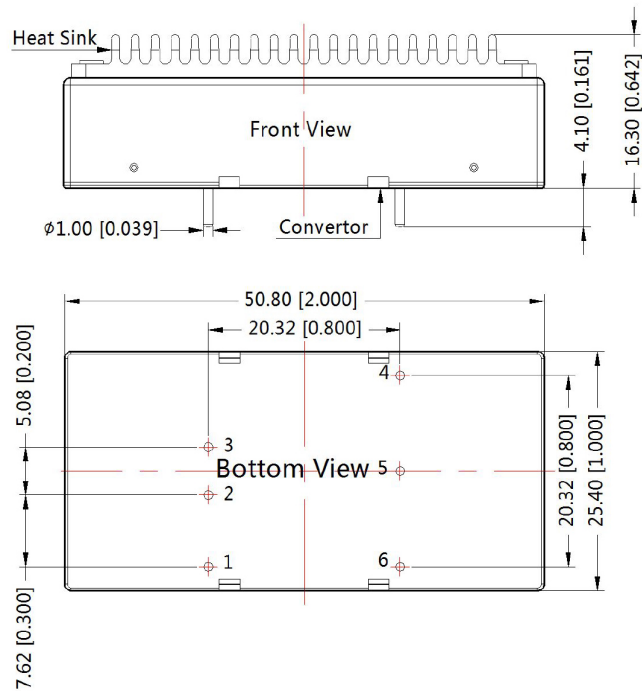

Pin-Out	
Pin	Function
1	Ctrl
2	GND
3	Vin
4	+Vo
5	Trim
6	0V

Note:

Unit: mm[inch]

General tolerances: $\pm 0.5\text{mm}$ [$\pm 0.02\text{inch}$]